

# Enphase Microinverter

(M250-60-230-S22, M215-60-230-S22-E, and M215-60-230-S22)



## Corporate Headquarters Contact Information

Enphase Energy Inc.  
1420 N. McDowell Blvd.  
Petaluma, CA 94954  
USA  
<http://www.enphase.com>  
[info@enphaseenergy.com](mailto:info@enphaseenergy.com)



## Other Information

Product information is subject to change without notice. All trademarks are recognised as the property of their respective owners.

User documentation is updated frequently; Check the Enphase website (<http://www.enphase.com/support>) for the latest information.

For warranty text refer to <http://www.enphase.com/warranty>.

For Enphase patent information refer to <http://enphase.com/company/patents/>.

© 2014 Enphase Energy Inc. All rights reserved.

## Audience

This manual is intended for use by professional installation and maintenance personnel.

# Table of Contents

Important Safety Information.....	4
Read this First .....	4
Product Labels.....	4
Safety and Advisory Symbols .....	4
Safety Instructions .....	4
General Safety .....	4
Microinverter Safety .....	5
Engage Cable and Accessory Safety .....	6
The Enphase Microinverter System .....	7
How the Microinverter Works.....	8
System Monitoring.....	8
Optimal Reliability.....	8
Ease of Design .....	8
Planning for Microinverter Installation .....	9
Compatibility and Capacity .....	9
Compatibility.....	9
Branch Circuit Capacity.....	9
Utility Service Requirements .....	9
Lightning and Surge Suppression.....	10
Parts and Tools Required .....	10
Enphase Equipment .....	10
Other Items.....	10
Example Single-Phase Design .....	11
Enphase Items Needed for Example Design.....	12
Non-Enphase Items Needed for Example Design .....	12
Enphase Microinverter Installation .....	13
Step 1: Register the System .....	14
Step 2: Connect the Envoy Communications Gateway .....	15
Step 3: Position the Enphase Engage™ Cable .....	16
Step 4: Install an AC Junction Box.....	17
Step 5: Attach the Microinverters to the Mounting Rail .....	18
Step 6: Dress the Engage Cable .....	19
Step 7: Connect the Microinverters.....	20
Step 8: Terminate the Unused End of the Engage Cable .....	21
Step 9: Connect the Engage Cable to AC Junction Box(es).....	22
Step 10: Complete the Installation Map .....	23
Step 11: Connect the PV Modules.....	23
Commissioning and Operation.....	24
Energise the System.....	24
Check the Envoy's progress .....	24
Configure the Grid Profile .....	25
Build the Virtual Array .....	25
Troubleshooting .....	26
Status LED Indications and Error Reporting .....	26
Start-up LED Operation.....	26
Post-Start-up LED Indications .....	26
Reported Faults.....	26
Troubleshoot an Inoperable Microinverter .....	27
Disconnect a Microinverter .....	28
Install a Replacement Microinverter.....	29
Engage Cable Planning and Ordering .....	30
Selecting Cable Type.....	30
Connector Spacing Options.....	30
Voltage Type and Conductor Count Options .....	30
Cabling Length Options .....	31
Planning for Cable Lengths and Type.....	31
Technical Data .....	33
Technical Considerations .....	33
Specifications .....	33
M250-60-230-S22 Specifications .....	33
M215-60-230-S22-E Specifications.....	35
M215-60-230-S22 Specifications .....	37
Engage Cable Specifications.....	38
Enphase Installation Map .....	40
Sample Wiring Diagram – 230 VAC, Single-Phase .....	41
Sample Wiring Diagram – 230 VAC, Three-Phase .....	42

# Important Safety Information

## Read this First

This manual contains important instructions for use during installation and maintenance of the Enphase M215 and M250 Microinverters™.

## Product Labels

The following symbols appear on the **product label** and are described here:



**WARNING:** Hot surface.



**DANGER:** Risk of electric shock.



Refer to product instructions.

## Safety and Advisory Symbols

To reduce the risk of electric shock, and to ensure the safe installation and operation of the Enphase® Microinverter, the following safety symbols appear throughout this document to indicate dangerous conditions and important safety instructions.



**DANGER!** This indicates a hazardous situation, which if not avoided, will result in death or serious injury.



**WARNING!** This indicates a situation where failure to follow instructions may be a safety hazard or cause equipment malfunction. Use extreme caution and follow instructions carefully.



**WARNING!** This indicates a situation where failure to follow instructions may result in burn injury.



**NOTE:** This indicates information particularly important for optimal system operation. Follow instructions closely.

## Safety Instructions

### General Safety



**CAUTION:** Before installing or using the Enphase Microinverter, read all instructions and cautionary markings in the technical description, on the Enphase Microinverter System, and on the photovoltaic (PV) equipment.



**DANGER:** Risk of electric shock. Do not use Enphase equipment in a manner not specified by the manufacturer. Doing so may cause death or injury to persons, or damage to equipment.



**DANGER:** Risk of electric shock. Be aware that installation of this equipment includes risk of electric shock. Do not install the AC junction box without first removing AC power from the Enphase System.



**DANGER:** Risk of electric shock. The DC conductors of this photovoltaic system are ungrounded and may be energised.



**WARNING:** Risk of electric shock. Always de-energise the AC branch circuit before servicing. Never disconnect the DC connectors under load.



**WARNING:** Risk of electric shock. Risk of fire. Only use electrical system components approved for wet locations.



**WARNING:** Risk of electric shock. Risk of fire. Only qualified personnel should troubleshoot, install, or replace Enphase Microinverters or the Engage Cable and Accessories.



**WARNING:** Risk of electric shock. Risk of fire. Ensure that all AC and DC wiring is correct and that none of the AC or DC wires are pinched or damaged. Ensure that all AC junction boxes are properly closed.



**WARNING:** Risk of electric shock. Risk of fire. Do not exceed the maximum number of microinverters in an AC branch circuit as listed in the manual. You must protect each microinverter AC branch circuit with a 20A maximum breaker.



**WARNING:** Do not connect Enphase Microinverters to the grid or energise the AC circuit(s) until you have completed all of the installation procedures and have received prior approval from the electrical utility company.



**NOTE:** To ensure optimal reliability and to meet warranty requirements, the Enphase Microinverter System must be installed according to the instructions in this manual.



**NOTE:** The AC and DC connectors on the cabling are rated as a disconnect only when used with an Enphase Microinverter.



**NOTE:** Protection against lightning and resulting voltage surge must be in accordance with local standards.



**NOTE:** Many PV modules have a central stiffening brace. In these cases, do not position the connector and microinverter at the exact centre of the PV module. Instead, position the drop connectors so that the connectors do not conflict with the braces.



**NOTE:** Completely install all microinverters and all system AC connections prior to installing the PV modules.

## Microinverter Safety



**WARNING:** Risk of Skin Burn. The body of the Enphase Microinverter is the heat sink. Under normal operating conditions, the temperature is 15°C above ambient, but under extreme conditions the microinverter can reach a temperature of 80°C. To reduce risk of burns, use caution when working with microinverters.



**WARNING:** Risk of electric shock. Risk of fire. If the AC cable on the microinverter is damaged, do not install the unit.



**WARNING:** Risk of electric shock. Risk of fire. Do not attempt to repair the Enphase Microinverter; it contains no user-serviceable parts. If it fails, contact Enphase customer service to obtain an RMA (return merchandise authorization) number and start the replacement process. Tampering with or opening the Enphase Microinverter will void the warranty.



**WARNING:** Risk of Equipment Damage. The M215 and M250 may be paired only with 60-cell PV modules.



**WARNING:** Risk of Equipment Damage. You must match the DC operating voltage range of the PV module with the allowable input voltage range of the Enphase Microinverter.



**WARNING:** Risk of Equipment Damage. The maximum open circuit voltage of the PV module must not exceed the specified maximum input DC voltage of the Enphase Microinverter.



**WARNING:** Risk of Equipment Damage. The microinverter must be installed under the module, out of rain and sun. Do not mount the microinverter in a position that allows long-term exposure to direct sunlight or in a vertical orientation that allows water to collect in the DC connector recess. Do not install the microinverter black side up or vertically, with the DC connectors facing up.



**WARNING:** Be aware that only qualified personnel may connect the Enphase Microinverter to the utility grid.



**NOTE:** The microinverters will not produce power until the Envoy Communications Gateway is installed and configured with an appropriate grid profile. For instructions, refer to the Envoy Installation and Operation Manual at <http://www.enphase.com>.



**NOTE:** The Enphase Microinverter has field-adjustable voltage and frequency trip points that may need to be set, depending upon local requirements. Only an authorised installer with the permission and following requirements of the local electrical authorities should make adjustments.



**NOTE:** The Enphase Microinverter works with single-phase or three-phase electrical service.

## Engage Cable and Accessory Safety



**DANGER:** Risk of electric shock. The Engage Cable terminator cap must not be installed while power is connected.



**WARNING:** Risk of electric shock. Risk of fire. When stripping the sheath from the Engage Cable, make sure the conductors are not damaged. If the exposed wires are damaged, the system may not function properly.



**WARNING:** Risk of electric shock. Risk of fire. Do not leave AC connectors on the Engage Cable uncovered for an extended period. If you do not replace the microinverter immediately, you must cover any unused connector with a sealing cap. Sealing caps may not be reused.



**WARNING:** Risk of electric shock. Risk of fire. Make sure protective sealing caps have been installed on all unused AC connectors. Unused AC connectors are live when the system is energised by the grid. Sealing caps may not be reused.



**WARNING:** Risk of electric shock. Treat all connector contacts as though they are live. The 5G2.5 Engage Cable drop connector contains two live phases.



**WARNING:** Use the terminator only once. If you open the terminator following installation, the latching mechanism is destroyed. Do not reuse the terminator. Do not circumvent or manipulate the latching mechanism.



**CAUTION:** When installing the Engage Cable, secure any loose cable to minimise tripping hazard.



**NOTE:** Check the labelling on the Engage Cable drop connectors to be sure that the cable matches the electrical utility service at the site. Use 5G2.5 Engage Cable at sites with three-phase service, or use 3G2.5 Engage Cable at sites with single-phase service.



**NOTE:** There are two release-holes in the drop connector on the cable. These are not for mounting but are used to disconnect the connector. Keep these release holes clear and accessible.



**NOTE:** When looping the Engage Cable, do not form loops smaller than 12 cm in diameter.



**NOTE:** If you need to remove a sealing cap, you must use the Enphase disconnect tool or a screwdriver. Sealing caps may not be reused.



**NOTE:** When installing the Engage Cable and accessories, adhere to the following:

- Do not expose the terminator cap or cable connections to directed, pressurised liquid (water jets, etc.).
- Do not expose the terminator cap or cable connections to continuous immersion.
- Do not expose the terminator cap or cable connections to continuous tension (e.g., tension due to pulling or bending the cable near the connection).
- Use only the connectors and cables provided.
- Do not allow contamination or debris in the connectors.
- Use the terminator cap and cable connections only when all parts are present and intact.
- Do not install or use in potentially explosive environments.
- Do not allow the terminator to come into contact with open flame.
- Make sure that all terminator cap seals are seated correctly in the wire organiser.
- Fit the terminator cap using only the prescribed tools and in the prescribed manner.
- Use the terminator to seal the conductor end of the Engage Cable; no other method is allowed.



**NOTE:** Do not use the shipping cap to cover unused connectors. The shipping cap does not provide an adequate environmental seal. Enphase sealing caps are required to protect against moisture ingress.

# The Enphase Microinverter System

The Enphase Microinverter® System™ is the world's most technologically advanced inverter system for use in utility-interactive applications.

The three key elements of an Enphase Microinverter System include the:

- Enphase Microinverter
- Enphase Envoy® Communications Gateway™
- Enphase Enlighten® web-based monitoring and analysis software

This integrated system maximises energy harvest, increases system reliability, and simplifies design, installation and management.



## 1 Enphase Microinverters

- are installed beneath each solar module
- maximise energy harvest
- send AC power over AC wiring to the AC mains
- also send performance data via the AC wiring

## 2 Envoy Communications Gateway

- plugs into an AC outlet
- collects information via the AC wiring
- transmits data through a standard broadband router to the Internet
- collects information and transmits it to Enlighten

## 3 Enphase Enlighten Monitoring

- provides monitoring and analysis
- allows performance data to be viewed from any web browser

## How the Microinverter Works

The Enphase Microinverter maximises energy production from your photovoltaic (PV) array. Each Enphase Microinverter is individually connected to one PV module in your array. This configuration means that an individual Maximum Peak Power Point Tracker (MPPT) controls each PV module. This ensures that the maximum power available from each PV module is exported to the electricity network regardless of the performance of the other PV modules in the array. That is, although individual PV modules in the array may be affected by shading, soiling, orientation, or PV module mismatch, the Enphase Microinverter ensures top performance for its associated PV module. The result is maximum energy production from your PV system.

## System Monitoring

Once you install the Envoy Communications Gateway and provide an Ethernet connection to your broadband router or modem, the Enphase Microinverters automatically begin reporting to the Enphase Enlighten web server. The Enlighten software presents current and historical system performance trends, and it informs you of PV system status.

## Optimal Reliability

Microinverter systems are inherently more reliable than traditional inverters. The distributed nature of a microinverter system ensures that there is no single point of system failure in the PV system. Enphase Microinverters are designed to operate at full power at ambient temperatures as high as 65° C (150° F). The microinverter housing is designed for outdoor installation and complies with the IP67 regulation:

IP67 protective factor definition: Entirely protected against the effects of dust and immersion.



**NOTE:** To ensure optimal reliability and to meet warranty requirements, the Enphase Microinverter must be installed according to the instructions in this manual.

## Ease of Design

PV systems using Enphase Microinverters are very simple to design and install. You will not need string calculations, and you can install individual PV modules in any combination of PV module quantity, type, age and orientation. You won't need to install cumbersome traditional inverters. Each microinverter quickly mounts on the mounting rail, directly beneath each PV module. Low voltage DC wires connect from the PV module directly to the co-located microinverter, eliminating the risk of personnel exposure to dangerously high DC voltage.



## Planning for Microinverter Installation

The Enphase Microinverter is compatible with most 60-cell PV modules and installs quickly and easily. It ships with integrated DC and AC cables and connectors. The DC connectors attach to the PV module, while the AC connector attaches directly to the Engage Cable. No additional cabling is needed.

The Engage Cable is available in two connector spacing options and two voltage types to meet varying site requirements. For Engage Cable ordering information, see “Engage Cable Planning and Ordering” on page 30.



**WARNING:** Be aware that installation of this equipment includes risk of electric shock. Normally earthed conductors may be unearthed and energised when an earth fault is indicated.

### Compatibility and Capacity

The Enphase M215 and M250 Microinverters are **electrically compatible** with most 60-cell PV modules. For more information, see Technical Data on page 33 of this manual.

Refer to the Enphase website (<http://www.enphase.com/support>) for a list of **electrically compatible** PV modules and approved mounting rail systems. To ensure **mechanical compatibility**, be sure to order the correct connector type for both microinverter and PV module from your distributor.

#### Compatibility

Model Number	Works with PV Module Type	PV Module Connector Type
M250-60-230-S22	60-cell, to 310 W or higher	MC-4 Type 2 Locking
M215-60-230-S22-E	60-cell, to 270 W or higher	MC-4 Type 2 Locking
M215-60-230-S22	60-cell, to 270 W or higher	MC-4 Type 2 Locking

#### Branch Circuit Capacity

Service type	Maximum M250s per AC branch circuit	Maximum M215s per AC branch circuit
230V single-phase	14	17
400V three-phase	24	27
400V three-phase, centre-fed*	42	51

\* To centre-feed a branch, divide the circuit into two sub-branch circuits protected by a single overcurrent protection device (OCPD).

#### Utility Service Requirements

The Enphase Microinverter works with single phase or three phase 230 VAC service. Measure AC line voltage at the electrical utility connection to confirm that it is within the ranges shown:

Single-Phase Service		Three-Phase Service	
L1 to neutral	207 to 253 Vac	L1 to L2 to L3	360 to 440 Vac
		L1, L2, L3 to neutral	207 to 253 Vac

## Lightning and Surge Suppression

Enphase Microinverters have integral surge protection, greater than most traditional inverters. However, if the surge has sufficient energy, the protection built into the microinverter can be exceeded, and the equipment can be damaged. For this reason, you must protect your system with lightning and/or surge suppression devices according to local regulation. Install devices that adhere to local standards.



**NOTE:** Protection against lightning and resulting voltage surge must be in accordance with local standards.

## Parts and Tools Required

In addition to the microinverters, PV modules, mounting rail, and associated hardware, you will need the following.

### Enphase Equipment

- Enphase Envoy® Communications Gateway



**BEST PRACTICE: Connect the Envoy before the solar installation is complete.**

When powered up and connected for the first time, the Envoy may retrieve an automatic upgrade from Enphase. Because this upgrade may take up to 20 minutes, connect the Envoy first (connect to both AC power and to the broadband router) so that the upgrade completes well before the solar module installation is complete. For more information, see the *Envoy Communications Gateway Installation and Operation Manual*.

- Engage Cable, as needed. (See “Engage Cable Planning and Ordering” on page 30.)



**NOTE: Order the correct Engage Cable type.** Installers must order Engage Cable for either single-phase or three-phase installations. Use 5G2.5 Engage Cable at sites with three-phase service, or use 3G2.5 Engage Cable at sites with single-phase service. All drop connectors on the Engage Cable bear labels indicating the cable voltage designation.

- Sealing caps, as needed (for any unused drops on the Engage Cable)
- Terminators, as needed (one needed at the end of each AC branch circuit)
- Enphase disconnect tool (number 2 and 3 Phillips screwdrivers can be substituted)
- Enphase phase coupler (needed for three phase installation)

### Other Items

- Outdoor-rated, weather-proof AC junction box(es)
- Gland or strain relief fitting (one per AC junction box)
- Bonding conductor, if required
- Torque wrench, sockets, spanners for mounting hardware
- Adjustable spanner or open-ended spanner (for terminators)
- Tool for PV module locking connectors
- Handheld mirror (to view indicator lights on the undersides of the microinverters)
- Laptop or other device for Envoy set up

## Example Single-Phase Design

The following installation diagram shows an example with four branches. The single-phase design shows four center-fed branches with 14 microinverters each. The PV modules are in landscape orientation. Tables following the diagram list required and optional equipment for this example.

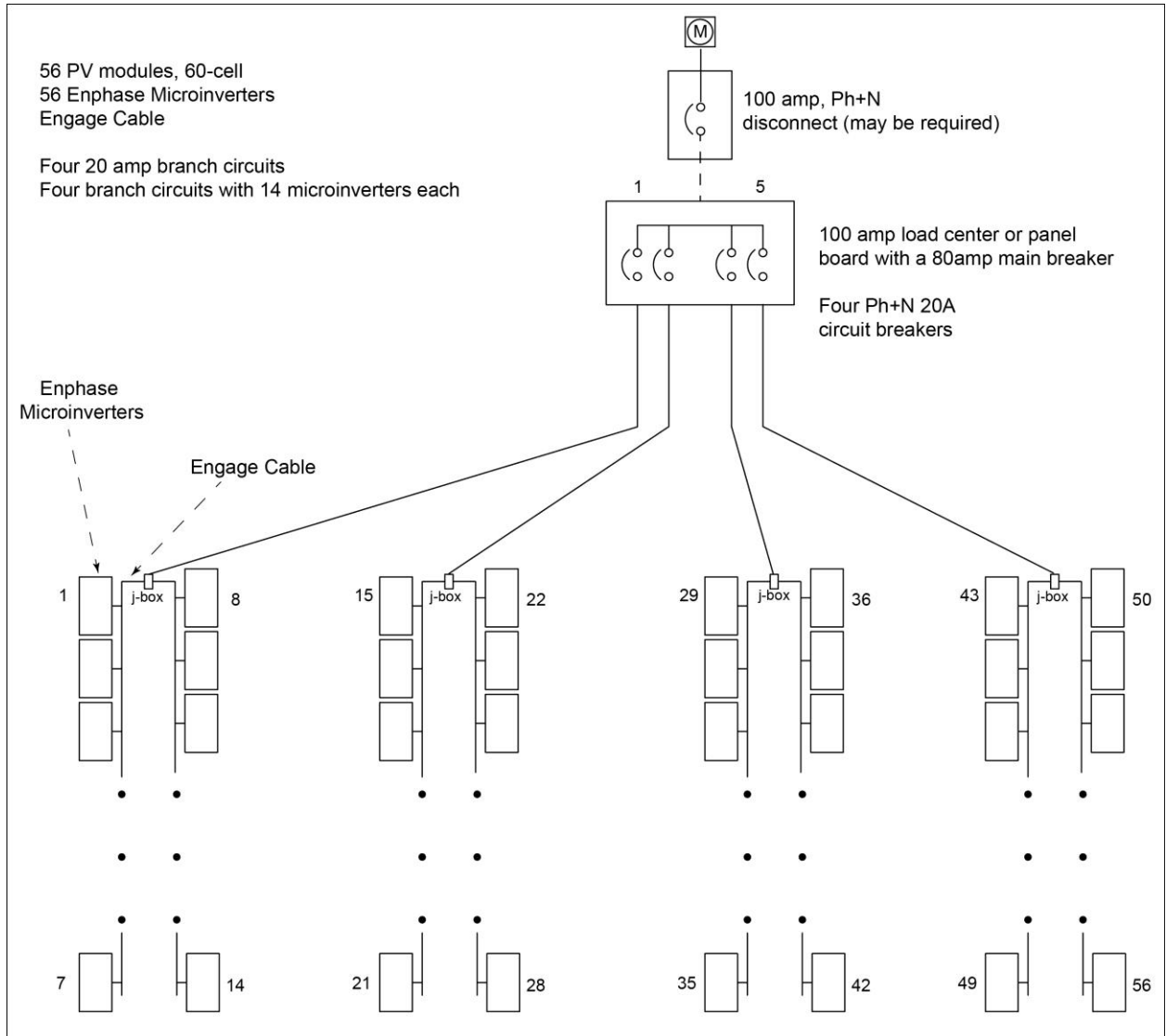

### Enphase Items Needed for Example Design

Quantity	Description	Order Number
56	M215 or M250 Microinverters	M250-60-230-S22 or M215-60-230-S22-E, or M215-60-230-S22
1 pack	Disconnect tool (each pack contains five tools)	ET-DISC-05
1 pack	Branch Terminator (each pack contains 10 terminators)	ET-TERM-10
1	Engage Cable	ET17-230-xxx (minimum 56 drops)
1 pack	Sealing caps (each pack contains 10 caps): Required only if there are any unused connectors on the Engage Cable; Unused connectors <b>must</b> be covered with this cap.	ET-SEAL-10
1	Envoy Communications Gateway	ENV-230
optional	Power line communication bridge pair	EPLC-02 (EU), EPLC-03 (UK) or EPLC-04 (AU)
optional	Wireless N USB adapter (802.11b/g/n)	WF-01

### Non-Enphase Items Needed for Example Design

Quantity	Description
56	60-cell PV modules
as needed	Tie wraps (cable ties)
4	Weather-proof junction box
4	20 amp circuit breaker single pole / Ph+N
1 (optional)	100 amp circuit breaker
1	100 amp load center with 1 80 amp main breaker
as needed	Rail / mounting hardware
as needed	Lightning protection device
as needed	Homerun conductors
as needed	Continuous grounding conductor
as needed	Torque wrench, sockets, wrenches for mounting hardware
as needed	Adjustable wrench or open-ended wrench (for terminator caps)
as needed	Inspection mirror (for viewing indicator lights on the undersides of the microinverters)

# Enphase Microinverter Installation

Installing the Enphase Microinverter System involves several key steps. Each step listed below is detailed in the following pages.

**Step 1:** Register the System

**Step 2:** Connect the Envoy® Communications Gateway™

**Step 3:** Position the Enphase Engage™ Cable

**Step 4:** Install an AC Junction Box

**Step 5:** Attach the Microinverters to the Mounting Rail

**Step 6:** Dress the Engage Cable

**Step 7:** Connect the Microinverters

**Step 8:** Terminate the Unused End of the Engage Cable

**Step 9:** Connect the Engage Cable to AC Junction Box(es)

**Step 10:** Complete the Installation Map

**Step 11:** Connect the PV Modules



**WARNING:** Risk of electric shock. Risk of fire. Always de-energise the AC branch circuit before servicing. Never disconnect the DC connectors under load.



**WARNING:** DO NOT connect Enphase Microinverters to the electricity network or energise the AC circuit(s) until you have completed all of the installation procedures as described in the following sections.



**NOTE:** Enphase Microinverters will not begin exporting power until the Envoy Communications Gateway is installed and has detected all of the microinverters at the site. In addition, the grid profile must be configured and the Envoy must have propagated these settings to the microinverters. For instructions on this procedure, refer to the *Envoy Installation and Operation Manual* at <http://www.enphase.com/support>.

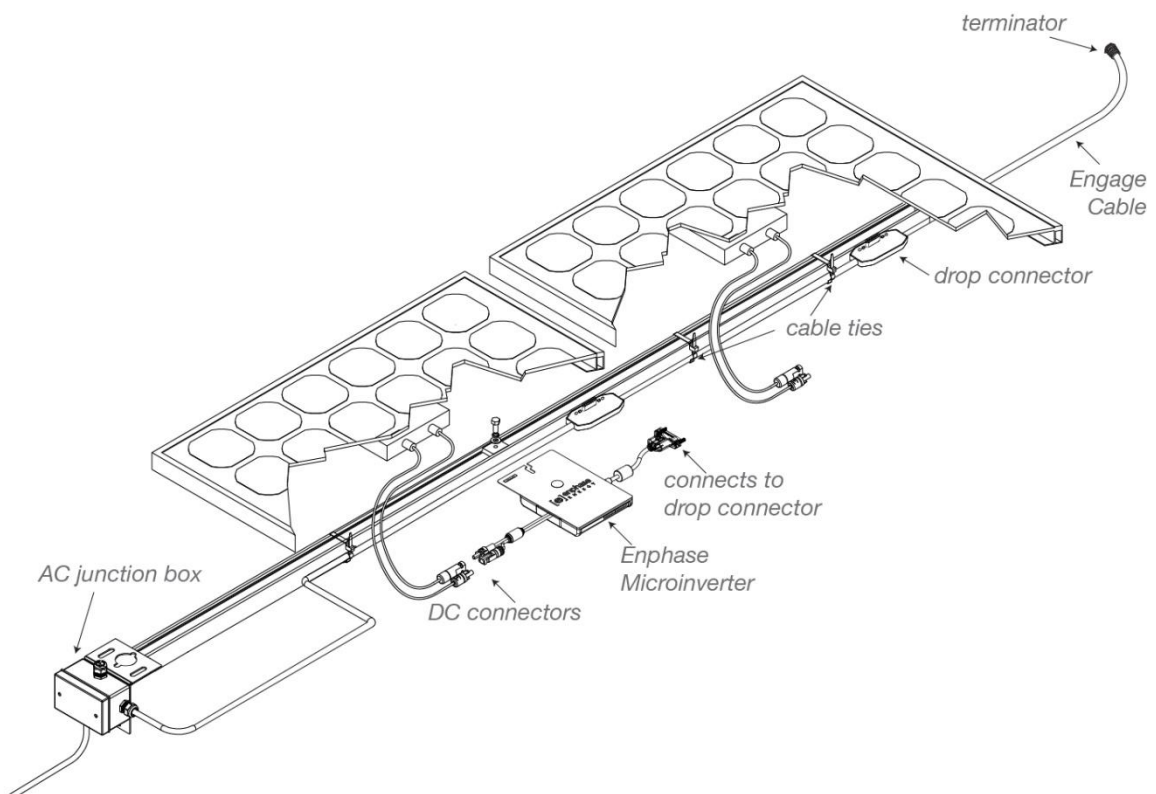

## Step 1: Register the System

Register the Envoy at the beginning of the PV installation.

- a. Use your previously issued username and password to log in to in Enlighten. If you haven't registered, go to [www.enphase.com](http://www.enphase.com) and click **Enlighten Login**.
- b. At the installer dashboard, click **Add a New System**. If you have already registered the site, find the system under **Installations in Progress**.
- c. Under **System**, enter the system Name, Type and Installer Reference (optional).
- d. Enter **Installer** information.
- e. Under **Owner**, enter the Name, Email, and Phone.
- f. Under **Location**, enter the Country and address information.
- g. Under **Envoy**, select the Internet Connection type and enter the Envoy Serial Number.
- h. Select the appropriate profile from the **Grid Profile** menu.



**NOTE:** The microinverters will not export power until the Envoy is installed and detects all the microinverters at the site. The grid profile must also be set and propagated to the microinverters.

- i. Under **Modules**, enter total number of modules, type, etc.
- j. Click **Save** to submit the form. You will receive a confirmation message: "Activation Created Successfully."

For more information on Grid Profiles or if you need to change the grid profile subsequent to this initial procedure, see the **Envoy Communications Gateway Installation and Operation Manual** at: <http://www.enphase.com/support>.

### System

\*Name  Installer Reference

\*Type

Third Party Owned (ex: PPA or Leased)

---

### Installer

---

### Owner

First Name

Last Name

Email

Phone

Owner will receive **MyEnlighten** for system performance monitoring.

### Location

Country

Street Address

Street Address 2

City

State/Province

Zip/Postal Code

---

### Envoy

\*Internet Connection  Grid Profile

Envoy Serial Number  Envoy Status

[Add Another Envoy](#)

---

### Modules

\*Total Number of PV Modules (Panels)

PV Module

Don't see your manufacturer/model? [Let us know](#)

### Installation

Microinverter Attachment Type

Array Type

Enter array-level details on the system settings page.

---

### Installation Map

Scan or photograph the system's installation map and upload the file(s) here.

Upload A File:

No file selected.

Must be PNG, JPG, GIF, OR PDF files under 2MB in size.

Install Map Label:

e.g. Branch Circuit 1, South Roof Face

---

### Production Estimate

Provide estimated system production data to enable production threshold and compare estimated to actual system performance. You may enter estimated production values for each array individually or for the system as a whole.

Array-level production estimates (enter on the system settings page)

System-level production estimate

Annual Degradation Factor

Percentage to reduce estimate each year to account for aging of PV modules.

## Step 2: Connect the Envoy Communications Gateway

The Envoy operates between the Enphase Microinverters and the Enphase Enlighten® web-based monitoring and analysis software. The Envoy collects energy and performance data from the microinverters over on-site AC power lines. It then forwards that data to Enlighten, via the Internet, for statistical reporting. The Envoy is capable of monitoring up to 600 Enphase Microinverters.

- a. Connect the Envoy to power and Internet according to the Envoy Quick Install Guide.



**NOTE:** If you are installing the Envoy (ENV-230) in a three-phase application, the power line communication signal must be “coupled” between the three phases to allow the Envoy to communicate with all of the microinverters in the system. Install a phase coupler or wire a capacitor into the system. With either solution, install the device on the load side of the over-current protection device. See the Enphase Technical Brief on Phase Coupling for your region at <http://www.enphase.com/support>.

- b. During start up, the Envoy LCD panel scrolls through the available language settings. When you see the setting you prefer, press the Menu button and hold for two seconds.
- c. Wait for the “+Web” indication on the Envoy’s LCD screen.
- d. Leave the Envoy running while you install the microinverters so that any required Envoy software upgrade completes.



**BEST PRACTICE:** When powered up and connected for the first time, the Envoy may retrieve an automatic upgrade from Enphase. Because this upgrade may take up to 20 minutes, connect the Envoy first at the site (connect to both AC power and the broadband router) so that it performs the upgrade well before the solar module installation is complete.



**WARNING!** Do not remove power from the Envoy if the LCD displays: “Upgrading. . . Do Not Unplug.”

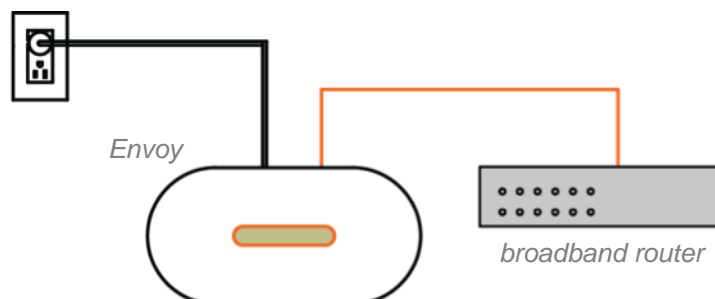

### Step 3: Position the Enphase Engage™ Cable

The Engage Cable is a continuous length of 2.5 mm<sup>2</sup>, outdoor rated cable with integrated connectors for microinverters. These connectors are preinstalled along the Engage Cable at intervals to accommodate PV module widths. The microinverters plug directly into the connectors, and the Engage Cable is terminated into the junction box that feeds electricity back to the system AC disconnect. For more information, see “Engage Cable Planning and Ordering” on page 30.



**NOTE: Make sure you are using the correct cable type.** Use 5G2.5 Engage Cable at sites with three-phase service, or use 3G2.5 Engage Cable at sites with single-phase service. Check the labelling on the drop connectors to verify the voltage type.

- a. Plan the cable route so that the drop connectors on the Engage Cable align with each PV module. Allow extra length for slack, cable turns and any obstructions.
- b. Measure the path of the AC branch circuit and cut a length of Engage Cable to meet your needs.
- c. Lay the Engage Cable along the route it will travel, positioning the connectors so that they align with the PV modules.



**WARNING:** Risk of fire. Plan the AC branches so that they do not exceed the maximum number of microinverters in an AC branch circuit as listed on page 9 of this manual. You must protect each microinverter AC branch circuit with a 20A maximum breaker.

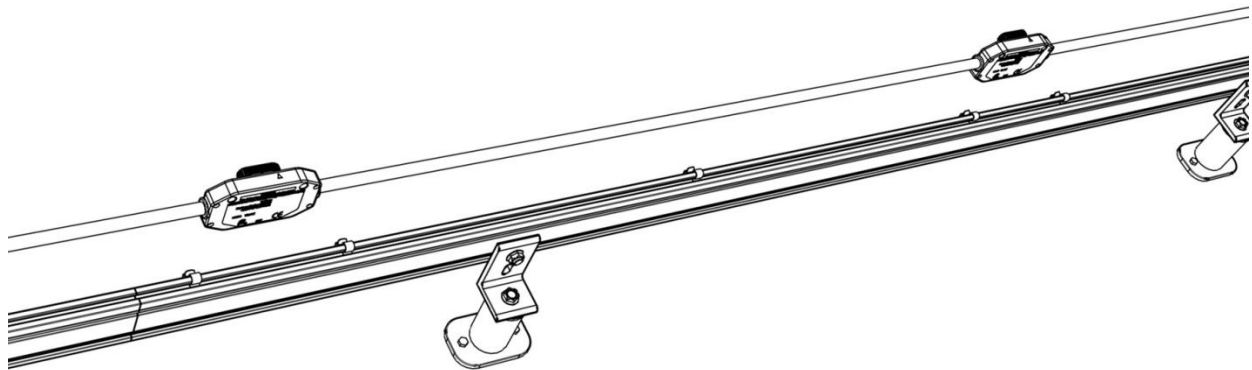

**NOTE:** Many PV modules have a central stiffening brace. In these cases, do **not** position the connector and microinverter at the exact centre of the PV module. Instead, position the drop connectors so that the connectors do not conflict with the braces.

- d. PV module widths vary by manufacturer. On the Engage Cable, connectors are spaced at intervals to allow for the widest PV modules compatible with Enphase Microinverters. If narrower PV modules are used, it may be necessary to account for excess cable by looping the cable at suitable intervals.



**NOTE:** When looping the Engage Cable, do not form loops smaller than 12 cm in diameter.



## Step 4: Install an AC Junction Box



**DANGER:** Risk of electric shock. Be aware that installation of this equipment includes risk of electric shock. Do not install the AC junction box without first removing AC power from the Enphase System.



**WARNING:** Only use electrical system components approved for wet locations.



**WARNING:** Do NOT exceed the maximum number of microinverters in an AC branch circuit as listed on page 9 of this manual.

- a. Install an appropriate junction box at a suitable location on the mounting system. You can centre feed the branch, or you can install the junction box at the end of a row of PV modules.



**Best Practice:** Centre-feed the branch circuit to minimise voltage rise in a fully-populated branch. This practice greatly reduces the voltage rise as compared with an end-fed branch. To centre-feed a branch, divide the circuit into two sub-branch circuits protected by a single overcurrent protection device (OCPD).

- b. Size the AC cable/wire size to account for voltage drop. Select conductor diameter based on the distance from the beginning of the microinverter AC branch circuit to the breaker in the AC mains.

All components of system wiring must be considered, including internal voltage drop within the length of Engage Cable. Typically, three wire sections and several wire terminations must be quantified. There is also some resistance associated with each circuit breaker. As all of these resistances are in series, they add together. Since the same current is flowing through each resistance, the total voltage drop is total current times the total resistance. For a single-phase system, the total resistance is equal to two times the one-way resistance. For a three-phase system, each of the three line currents and resistances must be calculated.

Standard guidelines for voltage drop on feeder and AC branch circuit conductors might not be sufficient for microinverter AC branch circuits that contain the maximum allowable microinverters. This is due to high inherent voltage rise on the AC branch circuit.

For more information, refer to our Technical Briefs on Voltage Drop at <http://www.enphase.com/support>.

- c. Provide an AC connection from the AC junction box back to the electricity network connection using equipment and practices as required by local regulations.

## Step 5: Attach the Microinverters to the Mounting Rail

- a. Mark the approximate centres of each PV module on the mounting rail.
- b. Evaluate the location of the microinverter with respect to the PV module DC junction box or any other obstructions.
- c. Ensure that the microinverter does not interfere with the PV module frame or stiffening braces.
- d. Ensure that the connector from the microinverter can easily reach the connector on the Engage Cable.
- e. Allow a minimum of 1.9 cm (0.75 inches) between the roof and the bottom of the microinverter. Also allow 1.3 cm (0.50 inches) between the back of the PV module and the top of the microinverter.



**WARNING: Risk of equipment damage.** You must install the microinverter under the module, out of rain and sun. Do not mount the microinverter in a position that allows long-term exposure to direct sunlight or in a vertical orientation that allows water to collect in the DC connector recess. Do not install the microinverter black-side up or vertically, with the DC connectors facing up.

- f. Mount one microinverter at each location using suitable hardware. The indicator light on the underside of the microinverter will be facing the roof.



**NOTE:** Installing the microinverter black side up or vertically, with the DC connectors facing up, is not permitted.

- g. Torque the microinverter fasteners to the values shown. Do not over torque.
  - 6 mm (1/4") mounting hardware – 5 Nm (45 to 50 in-lbs)
  - 8 mm (5/16") mounting hardware – 9 Nm (80 to 85 in-lbs)



**NOTE:** Using a power screwdriver to tighten the screws is not recommended due to the risk of thread galling.

- h. If you are using an earth bonding conductor to bond the microinverter chassis, attach the bonding conductor to the microinverter bonding screw.
- i. Torque the bonding screw as follows:
  - M250-60-230-S22: 4 to 5 Nm
  - M215-60-230-S22-E: 4 to 5 Nm
  - M215-60-230-S22: 2 Nm

Do not over torque. You may also earth the mounting rail and PV module to this conductor using a crimp connection.



**NOTE:** The AC output neutral is not bonded to earth inside the microinverter.

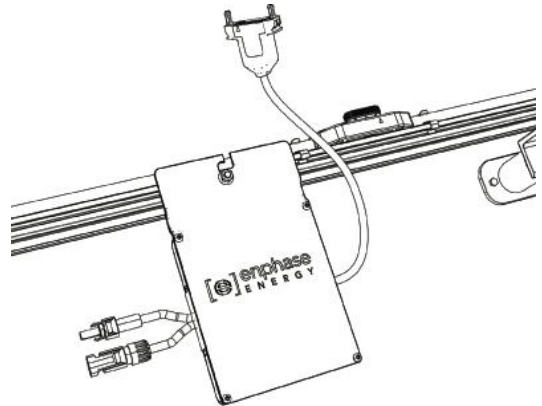

## Step 6: Dress the Engage Cable



**NOTE:** Adhere to the following requirements:

- Do not expose the cable connections to directed, pressurised liquid (water jets, etc.).
- Do not expose the cable connections to continuous immersion.
- Do not expose the AC connector to continuous tension (e.g., tension due to pulling or bending the cable near the connection)
- Use only the connectors and cables provided.
- Do not allow contamination or debris in the connectors.
- Use the cable and connectors only when all parts are present and intact.

- a. Attach the Engage Cable to the mounting rail using tie wraps.

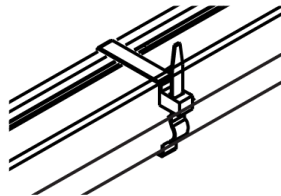

**NOTE:** There are two release-holes in the drop connector on the cable. These are **not** for mounting but are used to disconnect the connector. **Keep these release holes clear and accessible.**

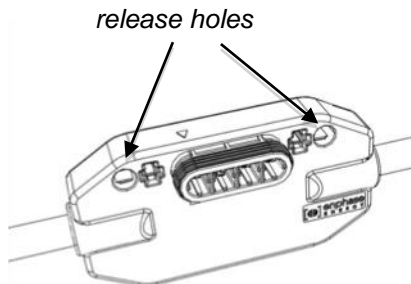

- b. Dress any excess in loops so that the Engage Cable does **not** contact the roof.

There are several ways to support the cable. One method is to place tie wraps on either side of the connector. Use tie wraps, or other support scheme to secure the cable between connectors.



**NOTE:** When looping the Engage Cable, do not form loops smaller than 12 cm in diameter.



**CAUTION:** Tripping Hazard. Loose cables can become a tripping hazard. Dress the Engage Cable to minimise this potential.

## Step 7: Connect the Microinverters

- a. Remove and discard the temporary shipping cap from the Engage Cable and connect the microinverter. There are two latching mechanisms within the connectors. Listen for **two** clicks as the connectors engage. Ensure that **both** latching mechanisms have engaged.
- b. Repeat for all microinverters in the AC branch circuit.
- c. Cover any unused connector with a sealing cap. Listen for two clicks as the connectors engage. Ensure that **both** latching mechanisms have engaged.

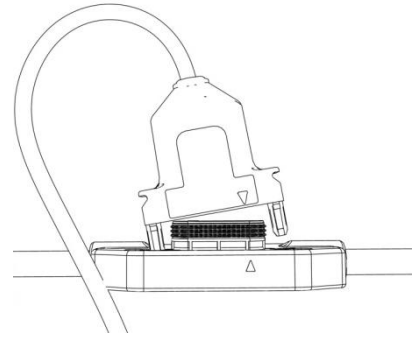

**NOTE: Do not use the shipping cap to cover unused connectors.** The shipping cap does not provide an adequate environmental seal. Enphase sealing caps are required for the system to be compliant to regulation and to protect against moisture ingress.

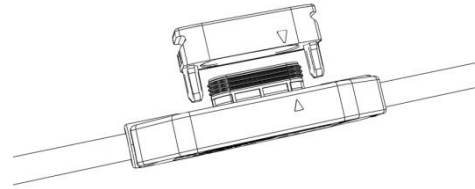

Enphase sealing caps are IP67 rated. Within the term “IP67”, “IP” indicates an Ingress Protection (IP) rating against dust and liquids. This specific rating of IP67 indicates that this connector protects against all dust particles and immersion in liquid.



**WARNING:** Risk of electric shock. Risk of fire. Make sure protective sealing caps have been installed on **all** unused AC connectors. Unused AC connectors are live when the system is energised by the electricity network. **Sealing caps may not be reused.**



**NOTE:** If you need to remove a sealing cap, you must use the Enphase disconnect tool or a screwdriver. See “Disconnect a Microinverter” on page 28. Sealing caps may not be reused.

## Step 8: Terminate the Unused End of the Engage Cable



**WARNING:** Risk of Electrical Shock. Do not install the terminator cap while power is connected.

Terminate the far end of the Engage Cable as follows.

- a. Remove 60mm (2.5 inches) of the cable sheath from the conductors.
- b. Slide the hex nut onto the Engage Cable.
- c. Insert the Engage Cable all the way into the wire organiser (up to the stop).
- d. Bend the individual wires back into the recesses in the wire organiser so that they angle back toward the cable.
- e. Cut the individual wires so that no excess extends outside of the wire organiser. The portions that angle back will need to extend enough to fit neatly into the 0.5 cm (0.2 in) recesses in the wire organiser and flush with the edge of the cap.
- f. Place cap over the wire organiser.
- g. Hold the cap with an Enphase disconnect tool, or insert a #2 Phillips screwdriver.
- h. Use a 22 mm (7/8 inch) spanner to tighten the hex nut until the latching mechanism is screwed all the way to the base. **Never unscrew the hex nut as this can twist and damage the cable.**
- i. Use a tie wrap to attach the cable to the mounting rail, so that the Engage Cable and terminator do not touch the roof.
- j. Ensure that all cabling is located underneath the PV module.

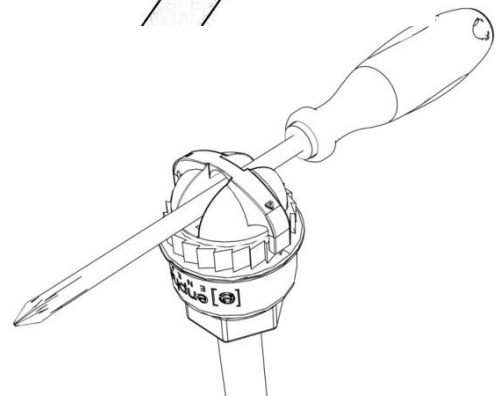
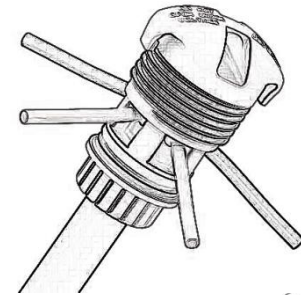
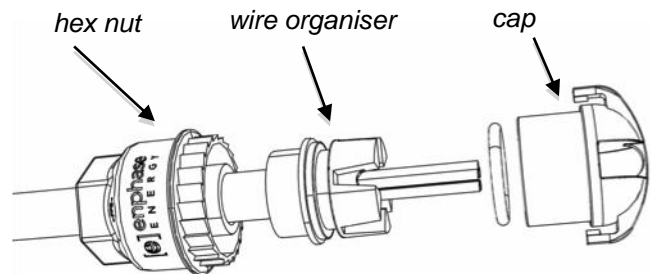

### Step 9: Connect the Engage Cable to AC Junction Box(es)

- a. Connect Engage Cable into the AC branch circuit junction box using an appropriate gland or strain relief fitting. The Engage Cable requires a strain relief connector with an opening of 1.3 cm (0.5 inches) in diameter.
- b. Connect the Engage Cable into additional AC junction boxes as needed to transition to conduit between smaller sub-arrays.

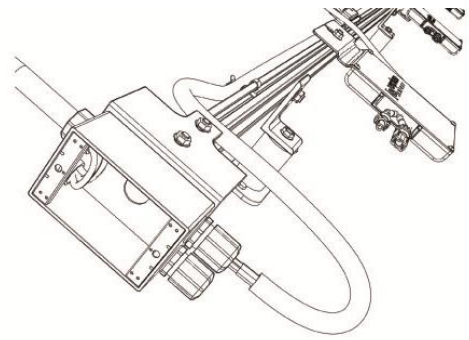

Refer to the wiring diagrams located on page 41 for more information.

Single-phase 3G2.5	Three-phase 5G2.5
L1 - Brown	L1 - Brown
(not present)	L2 - Black
(not present)	L3 - Grey
Neutral - Blue	Neutral - Blue
Earth – Green / yellow (acts as equipment earth)	Earth – Green / yellow (acts as equipment earth)

Balanced 400 Vac (3-phase) is accomplished by alternating phases between microinverters as shown:

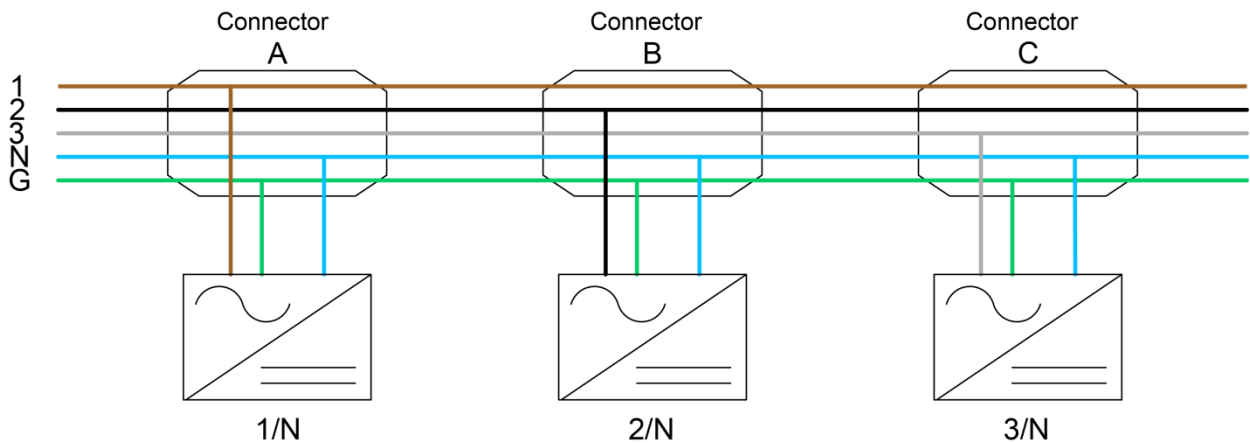

**WARNING:** Risk of electric shock. Treat all connector contacts as though they are live. The 5G2.5 Engage Cable drop connector contains two live phases.

## Step 10: Complete the Installation Map

The Enphase Installation Map is a diagrammatic representation of the physical location of each microinverter in your PV installation. You will create the virtual array in Enlighten from this map. Use the blank map on page 40 to record microinverter placement for the system, or provide your own layout if a larger or more intricate installation map is required.

You can build the system map manually, by peeling the serial number labels from the microinverters and placing the labels on the installation map, or you can use the scanning tool feature from the Enphase Installer Toolkit to easily build and configure a system. Refer to <http://enphase.com/products/arraygun/> for more information.

To manually build the Installation Map:

- Each Enphase Microinverter has a removable serial number label located on the mounting plate. Peel the removable serial number label from each Enphase Microinverter and affix it to the respective location on the Enphase installation map (see map on page 40). Remember to keep a copy of the installation map for your records.
- Draw a top-down view of the array using the Array Map template. Make sure to leave enough room to place the serial number stickers.
- When installing the microinverters, remove the serial number labels located next to the DC input cables and place them in the correct order on your drawing of the system. Remember to keep a copy of the installation map for your records.

## Step 11: Connect the PV Modules



**WARNING:** Risk of equipment damage. The M215 and M250 can be paired only with 60-cell PV modules.



**NOTE:** Completely install all microinverters and all system AC connections prior to installing the PV modules.

- Mount the PV modules above the microinverters.
- Mate the microinverters and PV modules as required. Repeat for all remaining PV modules using one microinverter for each PV module.

The status LED on the underside of each microinverter lights green six seconds after DC power is applied. It remains lit solid for two minutes, followed by six green blinks. After that, red blinks indicate that no grid is present. This is because the AC breaker is not turned on yet.

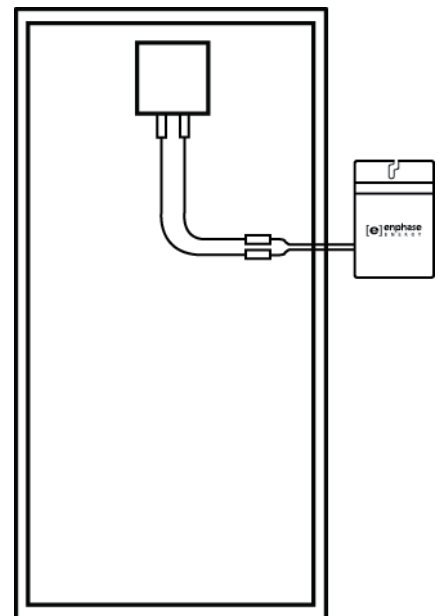

## Commissioning and Operation



**WARNING:** Risk of electric shock. Risk of fire. Qualified personnel only may connect the Enphase Microinverter to the electricity network.



**WARNING:** Risk of electric shock. Risk of fire. Ensure that all AC and DC wiring is correct. Ensure that none of the AC and DC wires are pinched or damaged. Ensure that all AC junction boxes are properly closed.



**REMINDER:** Enphase Microinverters will not begin exporting power until the Envoy Communications Gateway is installed and has detected all of the microinverters at the site. In addition, the grid profile must be configured and the Envoy must have propagated these settings to the microinverters.

For instructions on installing the Envoy and configuring the grid profile, refer to the *Envoy Installation and Operation Manual* at <http://www.enphase.com/support>.

### Energise the System

1. Turn ON the AC disconnect or circuit breaker (such as an isolation switch) for each microinverter AC branch circuit.
2. Turn ON the main AC switch.
3. The Enphase Microinverters will begin communicating over the power lines to the Envoy. The time required for the Envoy to discover all of the microinverters varies with the number of microinverters in the system and quality of the power line communications. At a typical residential installation, all of the microinverters are detected within 15 minutes. Large systems of 250 to 600 microinverters typically take one to two hours to detect all of the microinverters.
4. You will need to configure the microinverters with the appropriate grid profile before they can produce power. For instructions on this procedure, refer to the *Envoy Installation and Operation Manual* at <http://www.enphase.com/support>.



**NOTE:** If the Envoy has not been set up with a grid profile for the microinverters, they will not produce energy. The microinverters must be configured with the appropriate grid profile as part of the commissioning process.

### Check the Envoy's progress

Refer to the *Envoy Communications Gateway Installation and Operation Manual* at <http://www.enphase.com/support> for details on the following steps.

1. An automatic device scan runs for eight hours after the Envoy is installed. If this scan has expired, start a new scan.
  - Press and hold the Envoy menu button (on the right side of the Envoy).
  - Release the menu button when the LCD displays **Enable Device Scan**.
2. Check that the Envoy LCD shows a complete device count after about 30 minutes.
3. Check power line communications as shown by the number of bars on the Envoy LCD.
  - Press and hold the Envoy menu button (on the right side of the Envoy).
  - Release the menu button when the LCD displays **Enable Communication Check**.
4. Use the Envoy menu button to stop the scan when all devices are detected:
  - Press and hold the Envoy menu button (on the right side of the Envoy).
  - Release the menu button when the LCD displays **Disable Device Scan**.



## Configure the Grid Profile

If you did not set the Grid Profile during registration or if you need to change the Grid Profile, use the Envoy interface to configure the Grid Profile (alternate voltage and frequency trip points) for the system. Refer to the *Envoy Communications Gateway Installation and Operation Manual* at <http://www.enphase.com/support> for instructions.

## Build the Virtual Array

When the system is energised and the Envoy detects all the installed microinverters, you can create the virtual array in Enlighten from the installation map you created. Once the virtual array is built, Enlighten displays a graphic representation of the PV system. It also shows detailed current and historical performance information. Go to <http://www.enphase.com> for more information on the Enphase Enlighten web-based monitoring and analysis.

To scan and upload the map and build the array:

1. Scan the installation map and upload it to the Activation form online.
2. Use Array Builder to create the virtual array in Enlighten. Use your installation map as your reference.



**NOTE:** Go to <http://enphase.com/support/videos/> to view the Array Builder demo.

3. If you do not already have an account, go to <http://www.enphase.com> and click “Enlighten Login” to register.

# Troubleshooting

Adhere to all the safety measures described throughout this manual. Qualified personnel can use the following troubleshooting steps if the PV system does not operate correctly.



**WARNING:** Risk of electric shock. Do not attempt to repair the Enphase Microinverter; it contains no user-serviceable parts. If it fails, contact Enphase customer service to obtain an RMA (return merchandise authorisation) number and start the replacement process.

## Status LED Indications and Error Reporting

### Start-up LED Operation

The status LED on the underside of each microinverter lights green about six seconds after DC power is applied. It remains lit solid for two minutes, followed by six green blinks. After that, red blinks indicate that no grid is present if the system is not yet energised.

Six short red blinks after DC power is first applied to the microinverter indicate a failure during microinverter start-up.



LED on underside of micro-inverter

### Post-Start-up LED Indications

Use a handheld mirror to view indicator lights on the undersides of the microinverters. LED states are:

- **Flashing Green:** AC grid valid and communicating with Envoy
- **Flashing Orange:** AC grid valid but not able to communicate with Envoy
- **Flashing Red:** Not producing power. AC grid invalid (Voltage or Frequency). This may happen when the microinverters have not yet been configured with a Grid Profile.
- **Solid Red plus flashing Green:** DC input earth resistance fault active, AC grid valid and communicating with Envoy
- **Solid Red plus flashing Orange:** DC input earth resistance fault active, AC grid valid but not able to communicate with Envoy
- **Solid Red:** DC input earth resistance fault active and the AC grid is invalid. This may happen when the microinverters have not yet been configured with a Grid Profile.

### Reported Faults

All faults are reported to the Envoy. Refer to the *Envoy Installation and Operation Manual* for troubleshooting procedures.

## Troubleshoot an Inoperable Microinverter

To troubleshoot an inoperable microinverter, follow the steps in the order shown.



**WARNING:** Risk of electric shock. Always de-energise the AC branch circuit before servicing. Never disconnect the DC connectors under load.



**CAUTION:** The Enphase Microinverters are powered by DC power from the PV modules. Make sure you disconnect the DC connections and reconnect DC power to watch for the solid green about six seconds after connection to DC power and then six short green LED blinks two minutes after connection to DC power.

1. Make sure AC breakers and disconnects are closed.
2. Check the connection to the electricity network and verify the utility voltage and frequency are within allowable ranges.
3. Verify that AC line voltages at all solar power circuit breakers at the AC mains and subpanels are within the ranges shown in the following table.
4. Verify that AC line voltage at the electrical distribution board or consumer unit and at the AC junction box for each AC branch circuit are within the ranges are shown in the following table:

Single-phase service		Three-phase service	
L1 to neutral	207 to 253 Vac	L1 to L2 to L3	360 to 440 Vac
		L1, L2, L3 to neutral	207 to 253 Vac

5. Using an Enphase disconnect tool, disconnect the AC cable for the microinverter in question from the Engage Cable.
6. Verify that utility power is present at the microinverter by measuring line to neutral at the Engage Cable connector.
7. Visually check that the AC branch circuit connections (Engage Cable and AC connections) are properly seated. Reseat if necessary. Check also for damage, such as rodent damage.
8. Make sure that any upstream AC disconnects, as well as the dedicated circuit breakers for each AC branch circuit, are functioning properly and are closed.
9. Disconnect and re-connect the DC PV module connectors. The Status LED of each microinverter will light solid green a few seconds after connection to DC power and then blink green six times to indicate normal start-up operation about two minutes after connecting to DC power. The LED subsequently resumes normal operation if the grid is present. See page 26 for normal LED operation.
10. Attach an ammeter clamp to one conductor of the DC cables from the PV module to measure microinverter current. This will be under one Amp if AC is disconnected.
11. Verify the PV module DC voltage is within the allowable range for the microinverter, as shown in “Technical Data” on page 33 of this manual.
12. Swap DC leads with a known good, adjacent PV module. If after checking Enlighten periodically (this may take up to 30 minutes), the problem moves to the adjacent module, this indicates that the PV module isn’t functioning correctly. If it stays in place, the problem is with the microinverter. Call Enphase Customer Support for help in reading the microinverter data and for help in obtaining a replacement microinverter, if needed.
13. Check the DC connections between the microinverter and the PV module. The connection may need to be tightened or reseated. If the connection is worn or damaged, it may need replacement.
14. Verify with your electricity network that line frequency is within range.
15. If the problem persists, contact Customer Support at [support@enphaseenergy.com](mailto:support@enphaseenergy.com).

## Disconnect a Microinverter

If problems remain after following the troubleshooting steps listed previously, contact Enphase at [support@enphaseenergy.com](mailto:support@enphaseenergy.com). If Enphase authorises a replacement, follow the steps below. To ensure the microinverter is not disconnected from the PV modules under load, adhere to the following disconnection steps in the order shown:

1. De-energise the AC branch circuit breaker.
2. Disconnect the microinverter from the Engage Cable as follows:

Enphase AC connectors are tool-removable only. To disconnect a microinverter from the Engage Cable, insert the two large prongs of the disconnect tool (shown below) into the two holes in the drop connector. Rock the connector back and forth while pulling gently to disengage.

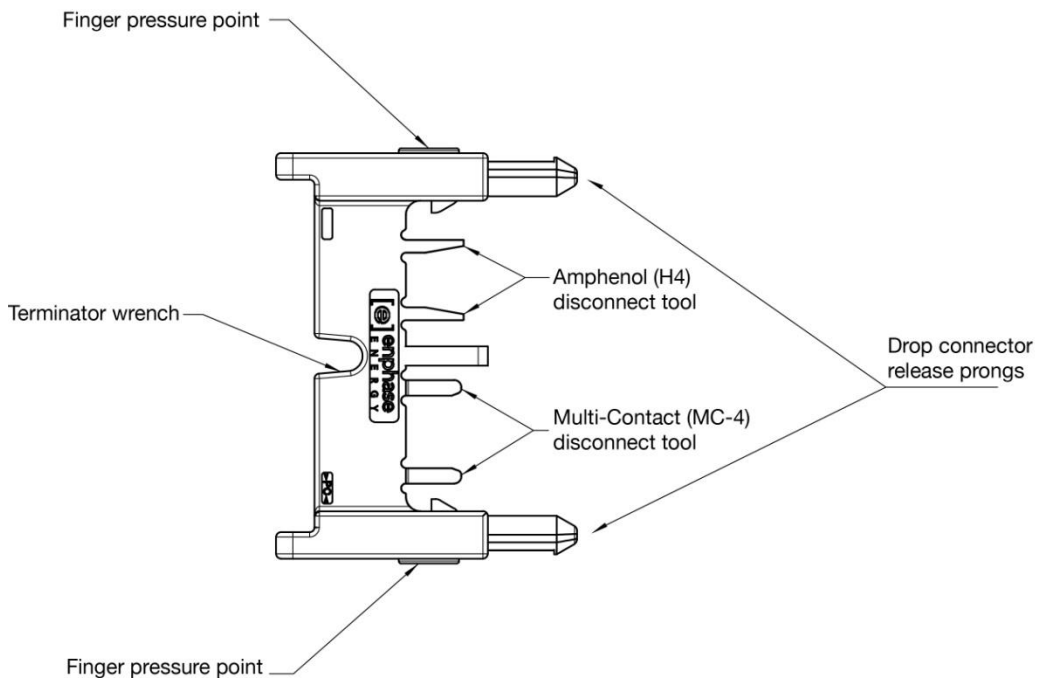

If the disconnect tool is not available, insert a #3 Phillips screwdriver into one hole, and rock that side of the drop connector out. Then, insert the screwdriver into the other hole and pull the connector out entirely.

3. Cover the PV module with an opaque cover.
4. Using a clamp on meter, verify there is no current flowing in the DC wires between the PV module and the microinverter.



**NOTE:** Take care when measuring DC current, as most clamp-on meters must be zeroed first and tend to drift with time.

5. Disconnect the PV module DC wire connectors from the microinverter using the Enphase disconnect tool.
6. If present, loosen the ground screw and remove the grounding electrode conductor.
7. Remove the microinverter from the mounting rail.



**WARNING:** Risk of electric shock. Risk of fire. Do not leave AC connectors on the Engage Cable uncovered for an extended period. If you do not plan to replace the microinverter immediately, you must cover any unused connector with a sealing cap. **Sealing caps may not be reused.**

## Install a Replacement Microinverter

If problems remain after troubleshooting, contact Enphase at [support@enphaseenergy.com](mailto:support@enphaseenergy.com). If Enphase authorises a replacement (RMA), replace the microinverter as follows:

1. When the replacement microinverter is available, verify that the AC branch circuit breaker is de-energised.
2. Attach the replacement microinverter to the mounting rail using hardware recommended by your mounting rail vendor.



**WARNING:** Risk of equipment damage. You must install the Enphase Microinverter under the module, out of rain and sun. Do not mount the microinverter in a position that allows long-term exposure to direct sunlight or in a vertical orientation that allows water to collect in the DC connector recess. Do not install the microinverter black-side up or vertically, with the DC connectors facing up.

3. Torque the microinverter fasteners to the values below. Do not over torque.
  - 6 mm (1/4") mounting hardware – 5 Nm (45 in-lbs)
  - 8 mm (5/16") mounting hardware – 9 Nm (80 in-lbs)



**NOTE:** Using a power screwdriver to tighten the fasteners is not recommended due to the risk of thread galling.

4. If you are using the bonding screw to bond the microinverter chassis, attach the bonding conductor to the screw. Torque the bonding screw as follows:
  - M250-60-230-S22: 4 to 5 Nm
  - M215-60-230-S22-E: 4 to 5 Nm
  - M215-60-230-S22: 2 Nm

Do not over torque.



**NOTE:** Using a power screwdriver to tighten the bonding screw is not recommended due to the risk of thread galling.

5. Attach the bonding conductor, if used, to the microinverter bonding screw.
6. Connect the microinverter to the Engage Cable drop connector. There are two latching mechanisms within the connectors. Listen for two clicks as the connectors engage. Ensure that **both** latching mechanisms have engaged.
7. Mount the PV module above the microinverter.
8. Mate the microinverter and PV module as required.
9. Energise the AC branch circuit breaker, and verify operation of the replacement microinverter by checking the indicator light on the underside of the microinverter. You may need a handheld mirror to see the indicator light.
10. Initiate a device scan at the Envoy. To do this, press and hold the Menu button on the Envoy for two seconds to bring up the Envoy menu on the LCD window. When the LCD window displays "Enable Device Scan", release the Menu button. This starts a 30-minute scan at the Envoy to discover the new microinverter.
11. Use Enlighten's Array Builder function to add the newly detected microinverter to the virtual array.
12. Ship the old microinverter to Enphase using the supplied return shipping label.

## Engage Cable Planning and Ordering

The Engage Cable is a continuous length of 2.5 mm<sup>2</sup>, outdoor-rated cable with integrated connectors for microinverters. These connectors are preinstalled along the Engage Cable at intervals to accommodate varying PV module widths. The microinverters plug directly into the cable connectors.

The cabling is compatible with a variety of PV racking systems. For a list of approved PV racking systems, refer to the PV Racking Compatibility document on the Enphase website (<http://www.enphase.com/support>).

### Selecting Cable Type

Enphase Engage Cable is available in two different voltage types and two connector spacing options. Depending upon installer needs, the cable is also available in different lengths.

### Connector Spacing Options

The gap between connectors on the Engage Cable can be either 1.025 metres (40") or 1.7 metres (67"). The 1.025 metre spacing is best suited for connecting PV modules installed in portrait orientation, while the 1.7 metre gap is best suited to PV modules installed in landscape orientation.

Cabling with connectors spaced at 1.025 metre for PV modules in portrait orientation

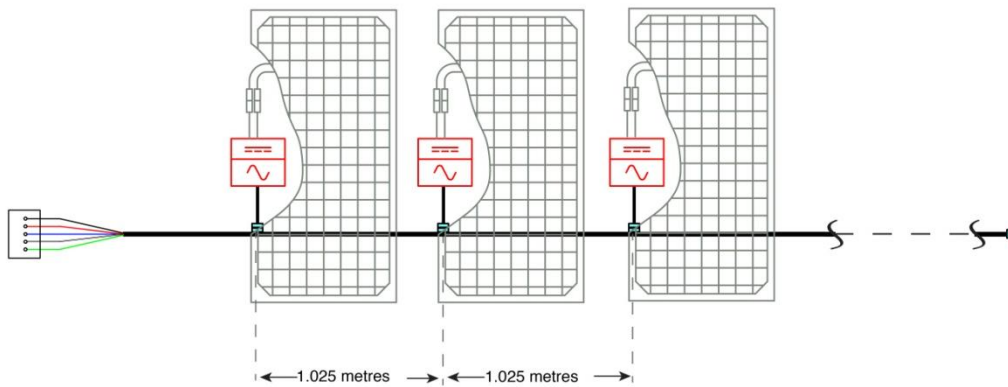

Cabling with connectors spaced at 1.7 metres for PV modules in landscape orientation

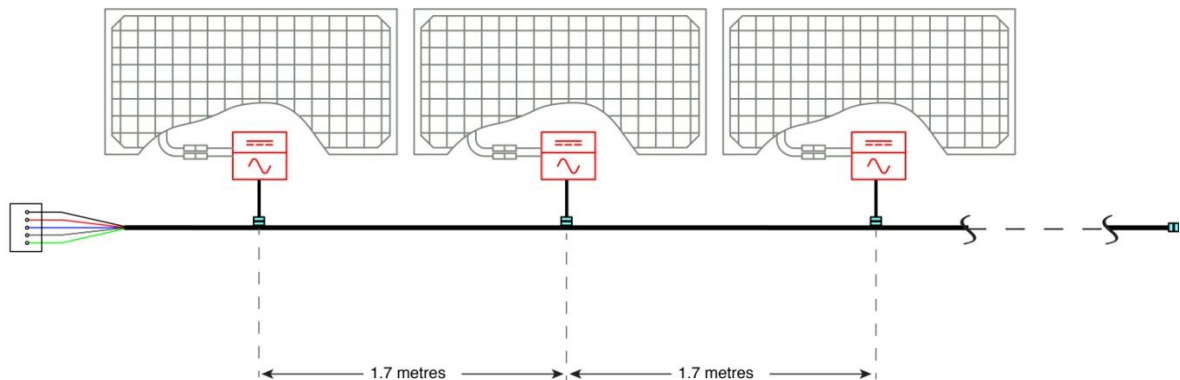

### Voltage Type and Conductor Count Options

The voltage types are either single-phase or three-phase. **All Engage Cable connectors bear labels indicating the voltage designation.** Single-phase (3G2.5) Engage Cable includes three conductors. Three-phase (5G2.5) Engage Cable includes five conductors. Because Enphase microinverters output onto one phase, the 5G2.5 Engage Cable balances the phases by rotating conductor use from one microinverter to the next as shown on page 22.

## Cabling Length Options

Engage Cabling is available in shorter lengths with 30-40 connectors, depending upon voltage type. Longer lengths can be ordered and cut to suit per order. Cable is also available with C2 rating. Ordering options include:

Model Number	Voltage/ conductors	Connector count	Connector spacing	PV module orientation	Approx. weight
ET10-230-40 ET10-230-40-C2	230 Vac, 3 conductors	40	1.025 m (40")	Portrait	14.5 kg
ET10-230-BULK ET10-230-BULK-C2	230 Vac, 3 conductors	240	1.025 m (40")	Portrait	over 100 kg
ET10-400-30 ET10-400-30-C2	400 Vac, 5 conductors	30	1.025 m (40")	Portrait	12.3 kg
ET10-400-BULK ET10-400-BULK-C2	400 Vac, 5 conductors	240	1.025 m (40")	Portrait	over 100 kg
ET17-230-40 ET17-230-40-C2	230 Vac, 3 conductors	40	1.7 m (67")	Landscape	20 kg
ET17-230-BULK ET17-230-BULK-C2	230 Vac, 3 conductors	240	1.7 m (67")	Landscape	over 100 kg
ET17-400-30 ET17-400-30-C2	400 Vac, 5 conductors	30	1.7 m (67")	Landscape	17.3 kg
ET17-400-BULK ET17-400-BULK-C2	400 Vac, 5 conductors	240	1.7 m (67")	Landscape	over 100 kg

## Planning for Cable Lengths and Type

The Cabling System is flexible enough to adapt to almost any solar design. To determine the length and cable type that you need, apply the following considerations:

- **Account for the number of Enphase Microinverters to be installed on the AC branch circuit.** Make sure to allocate the correct number of connectors, including extra connectors for gaps and turns.
- **Plan for additional cable length to reach from the AC branch circuit junction box to the first microinverter.** If greater than half a connector interval is needed, you may need to allow for one (or more) unused connectors in order to span this distance. You must cover unused connectors with Enphase watertight sealing caps.
- **Minimise the number of unused Engage Cable connectors** with three-phase systems. When cable connectors are left unused on a three-phase system, it creates a phase imbalance on the branch circuit. If multiple cable connectors are skipped over multiple branch circuits, the imbalance can multiply.

You can sometimes avoid skipping Engage Cable connectors by using Engage Couplers. Use the Engage Coupler to connect two Engage Cables or to connect Engage Cable to field cable.

There are many possible scenarios for each type of connection, but they generally fall into four categories:

Engage Cable to Engage Cable:

1. Make use of leftover lengths of Engage Cable
2. Transition between portrait and landscape Engage Cable

Engage Cable to Field Cable (such as Engage Cable, H07BQ-F, U-1000 RO2V, FG7OR, NYY-J)

3. Transition between sub-arrays on the same circuit
4. Create wiring extensions for Engage Cable

In situations where you cannot use an Engage Coupler, you can use an electrical junction box to transition between cable types.

- **Account for additional lengths of cable** when calculating total voltage rise (voltage drop). Refer to the Technical Brief on Voltage Drop at <http://www.enphase.com/support>.
- **Plan for additional length to reach from one row of PV modules to the next.** If the PV modules are laid out in multiple rows, the distance from one row to the next often requires additional cabling length.
- **Account for bend radius.** When planning cabling turns or loops, you must account for a minimum bend radius of 12 cm.
- **Consider additional cabling when installing multiple sub-arrays.** Often, an AC branch circuit may be composed of several smaller sub-arrays across more than one roof plane. In this case, cut the cable to service each smaller array, and connect the sub-arrays together using an Engage Coupler, or an appropriately rated AC junction box and conduit. Accomplish the transition from cable to conduit as required by local standards. Cover unused connectors with Enphase sealing caps.
- **Account for any mixture of PV modules in both portrait and landscape orientation.** When PV modules are installed in mixed orientation (both portrait and landscape orientation), there are three choices for cabling:
  1. Cabling with 1.025-meter spacing between connectors results in cleanest install for the PV modules in portrait orientation. For PV modules placed in landscape orientation, plan for an unused connector between each PV module to accommodate the required additional distance. Cover unused connectors with Enphase watertight sealing caps.
  2. Cabling with 1.7-meter spacing between connectors results in cleanest install for PV modules in landscape orientation, but requires that any additional cable length between PV modules in portrait orientation be coiled and dressed so that cabling does not contact the roof. Cover unused connectors with Enphase watertight sealing caps.
  3. Transition between 1.025 and 1.7-meter spaced cable options using an outdoor-rated junction box. Install this junction box to the PV racking.



# Technical Data

## Technical Considerations

Enphase Microinverters are electrically compatible with most 60-cell PV modules. Be sure to verify the voltage and current specifications of your PV module match those of the microinverter. For more information, refer to our list of compatible PV modules at <http://www.enphase.com/support>.



**WARNING:** Risk of equipment damage. You must match the DC operating voltage range of the PV module with the allowable input voltage range of the Enphase Microinverter.



**WARNING:** Risk of equipment damage. The maximum open circuit voltage of the PV module must not exceed the specified maximum input voltage of the Enphase Microinverter.

The output voltage and current of the PV module depends on the quantity, size and temperature of the PV cells, as well as the insolation on each cell. The highest PV module output voltage occurs when the temperature of the cells is the lowest and the PV module is at open circuit (not operating). The maximum short circuit current rating of the PV module must be equal to or less than the maximum input DC short circuit current rating of the microinverter.

## Specifications

See specifications in the following tables for:

- M250-60-230-S22
- M215-60-230-S22-E
- M215-60-230-S22
- Engage Cable

### M250-60-230-S22 Specifications

Enphase M250-60-230-S22 Microinverter				
Topic	Unit	Min	Typical	Max
<b>DC Parameters</b>				
Recommended maximum input power	W			310
MPPT voltage range	V	27		39
Operating range	V	16		48
Maximum DC input voltage	V			48
Minimum / Maximum start voltage	V	22		48
Maximum DC input short circuit current	A			15
Maximum DC input current	A			10.0
<b>AC Parameters</b>				
Peak AC output power	W		258	
Maximum AC output Power (-40 to 65 °C)	W		250	
Output power factor		0.95	0.99	1
Nominal AC output voltage			230	
Continuous AC output current, 230 Vac	A		1.09	
Number of AC phases			1	

Enphase M250-60-230-S22 Microinverter				
Topic	Unit	Min	Typical	Max
<b>Operational Data</b>				
Maximum microinverters per 20 amp AC branch circuit				
230 Vac		1		14
400 Vac (three-phase)		1		24
400 VAC (three-phase, centre fed)		1		42
Total Harmonic Distortion	%		3.0	5
Internal operating temperature range	°C	-40		85
External (ambient) operating temperature range	°C	-40		65
<b>Efficiency</b>				
EN50530 weighted efficiency (EU)	%		95.7	
Static MPPT efficiency (weighted, EN 50530)	%		99.6	
Dynamic MPPT efficiency (weighted, EN 50530) slow irradiation changes	%		99.3	
Dynamic MPPT efficiency (weighted, EN 50530) fast irradiation changes	%		99.3	
Dynamic MPPT efficiency (weighted, EN 50530) start up and shut down	%		99.8	
Night Tare Loss	W		0.055	
<b>Features and Compliance</b>				
Dimensions, not including mounting bracket (approximate)	17.9 cm x 17.2 cm x 2.8 cm			
Weight	1.66 Kg			
Enclosure environmental rating	IP67			
Connector type	MC4			
Cooling	Convective – no fan			
Communication	Power line			
ADD pollution rating	2			
Grid Compliance	<ul style="list-style-type: none"> <li>• France VDE0126</li> <li>• Belgium C10_11</li> <li>• Italy CEI_0-21</li> <li>• Luxembourg VDE0126</li> <li>• Luxembourg C10_11</li> <li>• Netherlands EN50438</li> <li>• United Kingdom G83/2, G59/2</li> <li>• Australia AS4777</li> </ul>			

Enphase M250-60-230-S22 Microinverter				
Topic	Unit	Min	Typical	Max
Other Compliance	<ul style="list-style-type: none"> <li>• Directive 2006/95/EC,</li> <li>• Directive 2004/108/EC,</li> <li>• EN 50065-1:2001</li> <li>• EN 50065-2-1:2003</li> <li>• EN 50065-2-2:2003</li> <li>• EN 50065-2-3:2003</li> <li>• EN 61000-3-2:2006</li> <li>• EN 61000-3-3:1995</li> <li>• EN 61000-6-1:2007</li> <li>• EN 61000-6-2:2005</li> <li>• EN 61000-6-3:2007</li> <li>• EN 61000-6-4:2007</li> <li>• EN 62109-1:</li> <li>• EN 62109-2: 2009</li> <li>• VDE-0126-1-1</li> <li>• C10/11</li> </ul>			
Integrated AC disconnect	The AC connector has been evaluated and approved for use as the required load-break disconnect.			
Protective class	1			

### M215-60-230-S22-E Specifications

Enphase M215-60-230-S22-E Microinverter				
Topic	Unit	Min	Typical	Max
<b>DC Parameters</b>				
Recommended maximum input power	W			270
MPPT voltage range	V	27		39
Operating range	V	16		48
Maximum DC input voltage	V			48
Minimum / Maximum start voltage	V	22		48
Maximum DC input short circuit current	A			15
Maximum DC input current	A			10.0
<b>AC Parameters</b>				
Peak AC output power	W		225	
Maximum AC output Power (-40 to 65 °C)	W		215	
Output power factor		0.95	0.99	1
Nominal AC output voltage			230	
Continuous AC output current, 230 Vac	A		1.09	
Number of AC phases			1	
<b>Operational Data</b>				
Maximum microinverters per 20 amp AC branch circuit				
230 Vac		1		17
400 Vac (three-phase)		1		27
400 VAC (three-phase, centre fed)		1		51

Enphase M215-60-230-S22-E Microinverter				
Topic	Unit	Min	Typical	Max
Total Harmonic Distortion	%		3.0	5
Internal operating temperature range	°C	-40		85
External (ambient) operating temperature range	°C	-40		65
Efficiency				
EN50530 weighted efficiency (EU)	%		95.7	
Static MPPT efficiency (weighted, EN 50530)	%		99.6	
Dynamic MPPT efficiency (weighted, EN 50530) slow irradiation changes	%		99.3	
Dynamic MPPT efficiency (weighted, EN 50530) fast irradiation changes	%		99.3	
Dynamic MPPT efficiency (weighted, EN 50530) start up and shut down	%		99.8	
Night Tare Loss	W		0.055	
Features and Compliance				
Dimensions, not including mounting bracket (approximate)	17.9 cm x 17.2 cm x 2.8 cm			
Weight	1.66 Kg			
Enclosure environmental rating	IP67			
Connector type	MC4			
Cooling	Convective – no fan			
Communication	Power line			
ADD pollution rating	2			
Grid Compliance	<ul style="list-style-type: none"> <li>• France VDE0126</li> <li>• Belgium C10_11</li> <li>• Italy CEI_0-21</li> <li>• Luxembourg VDE0126</li> <li>• Luxembourg C10_11</li> <li>• Netherlands EN50438</li> <li>• United Kingdom G83/2, G59/2</li> <li>• Australia AS4777</li> </ul>			
Other Compliance	<ul style="list-style-type: none"> <li>• Directive 2006/95/EC,</li> <li>• Directive 2004/108/EC,</li> <li>• EN 50065-1:2001</li> <li>• EN 50065-2-1:2003</li> <li>• EN 50065-2-2:2003</li> <li>• EN 50065-2-3:2003</li> <li>• EN 61000-3-2:2006</li> <li>• EN 61000-3-3:1995</li> <li>• EN 61000-6-1:2007</li> <li>• EN 61000-6-2:2005</li> <li>• EN 61000-6-3:2007</li> <li>• EN 61000-6-4:2007</li> <li>• EN 62109-1:</li> <li>• EN 62109-2: 2009</li> <li>• VDE-0126-1-1</li> <li>• C10/11</li> </ul>			
Integrated AC disconnect	The AC connector has been evaluated and approved for use as the required load-break disconnect.			

Enphase M215-60-230-S22-E Microinverter				
Topic	Unit	Min	Typical	Max
Protective class	1			

## M215-60-230-S22 Specifications

Enphase M215-60-230-S22 Microinverter				
Topic	Unit	Min	Typical	Max
<b>DC Parameters</b>				
Recommended maximum input power	W			270
MPPT voltage range	V	22	29	36
Operating range	V	16		36
Maximum DC input voltage	V			45
Minimum / Maximum start voltage	V	22		45
Maximum DC input short circuit current	A			15
Maximum DC input current	A			10.5
<b>AC Parameters</b>				
Peak AC output power	W		225	
Maximum AC output Power (-40 to 65 °C)	W		215	
Output power factor		0.95	0.99	1
Nominal AC output voltage			230	
Nominal AC output current, 230 Vac	A		.94	
Number of AC phases			1	
<b>Operational Data</b>				
Maximum microinverters per 20 amp AC branch circuit				
230 Vac		1		17
400 Vac (three-phase)		1		27
400 VAC (three-phase, centre fed)		1		51
Total Harmonic Distortion	%		3.0	5
Internal operating temperature range	°C	-40		85
External (ambient) operating temperature range	°C	-40		65
<b>Efficiency</b>				
EN50530 weighted efficiency (EU)	%		95.4	
Static MPPT efficiency (weighted, EN 50530)	%		99.6	
Dynamic MPPT efficiency (weighted, EN 50530) slow irradiation changes	%		99.3	
Dynamic MPPT efficiency (weighted, EN 50530) fast irradiation changes	%		99.3	
Dynamic MPPT efficiency (weighted, EN 50530) start up and shut down	%		99.8	
Night Tare Loss	mW		50	
<b>Features and Compliance</b>				
Dimensions, not including mounting bracket (approximate)	17.2 cm x 16.4 cm x 2.5 cm			
Weight	1.6 Kg			

Enphase M215-60-230-S22 Microinverter				
Topic	Unit	Min	Typical	Max
Enclosure environmental rating	IP67			
Connector type	MC4			
Cooling	Convective – no fan			
Communication	Power line			
ADD pollution rating	2			
Grid Compliance	<ul style="list-style-type: none"> <li>• France VDE0126</li> <li>• Belgium C10_11</li> <li>• Italy CEI_0-21</li> <li>• Luxembourg VDE0126</li> <li>• Luxembourg C10_11</li> <li>• Netherlands EN50438</li> <li>• United Kingdom G83/2, G59/2</li> <li>• Australia AS4777</li> </ul>			
Other Compliance	<ul style="list-style-type: none"> <li>• Directive 2006/95/EC,</li> <li>• Directive 2004/108/EC,</li> <li>• EN 50065-1:2001</li> <li>• EN 50065-2-1:2003</li> <li>• EN 50065-2-2:2003</li> <li>• EN 50065-2-3:2003</li> <li>• EN 61000-3-2:2006</li> <li>• EN 61000-3-3:1995</li> <li>• EN 61000-6-1:2007</li> <li>• EN 61000-6-2:2005</li> <li>• EN 61000-6-3:2007</li> <li>• EN 61000-6-4:2007</li> <li>• EN 62109-1:</li> <li>• EN 62109-2: 2009</li> <li>• VDE-0126-1-1</li> <li>• C10/11</li> </ul>			
Integrated AC disconnect	The AC connector has been evaluated and approved for use as the required load-break disconnect.			
Protective class	1			



## Engage Cable Specifications

Specification	Value
System temperature range (ambient)	-40°C to +65°C (-40°F to 149°F)
Engage Cable temperature rating	90°C Dry / 90°C Wet
VDE License for 230V Cable	40033278
Engage Cable	H07BQ-F for 3G2.5
Environmental protection rating	IEC 60529 IP67
UV exposure	EN ISO 4892-2
Conductor gauge	Single-phase 3G2,5 mm <sup>2</sup> Three-phase 5G2,5 mm <sup>2</sup>

Specification	Value
Maximum current carrying capacity of the Cable Single-phase 3G2,5 mm <sup>2</sup> Three-phase 5G2,5 mm <sup>2</sup>	20 amperes 16 amperes
Engage Cable bundle diameter	1.1 cm
Drop connector dimensions	11.8 cm x 6.0 cm x 3.2 cm
Terminator dimensions	3.6 cm diameter x 5.1 cm tall

# Enphase Installation Map

To sheet / Vers la page / Al foglio / Zu Blatt / Naar pagina: \_\_\_\_\_

Panel Group / Groupe de modules / Gruppo di moduli / Modulgruppe / Modulegroep: Azimuth / Azimut: Tilt / Inclinaison / Inclinazone / Neigungswinkel / Helling: sheet / page / foglio / Blatt / pagina _____ / _____		Client / Cliente / Kunde / Cliënt:					Installer / Installateur / Installatore:		N S E W / N S E O N S O W / N Z O W	
1	2	3	4	5	6	7				
A										
B										
C										
D										
E										
F										
G										
H										
J										
K										
L										
M										
Envoy serial label / étiquette de numéro de série / etichette di serie Envoy / Serien Nummer / Label seriennummer:									INSTALLATION MAP / PLAN D'INSTALLATION MAPPA INSTALLAZIONE / INSTALLATIONSPLAN INSTALLATIE KAART	

To sheet / Vers la page / Al foglio / Zu Blatt / Naar pagina: \_\_\_\_\_

© 2014 Enphase Energy Inc. All rights reserved.



### Sample Wiring Diagram – 230 VAC, Single-Phase

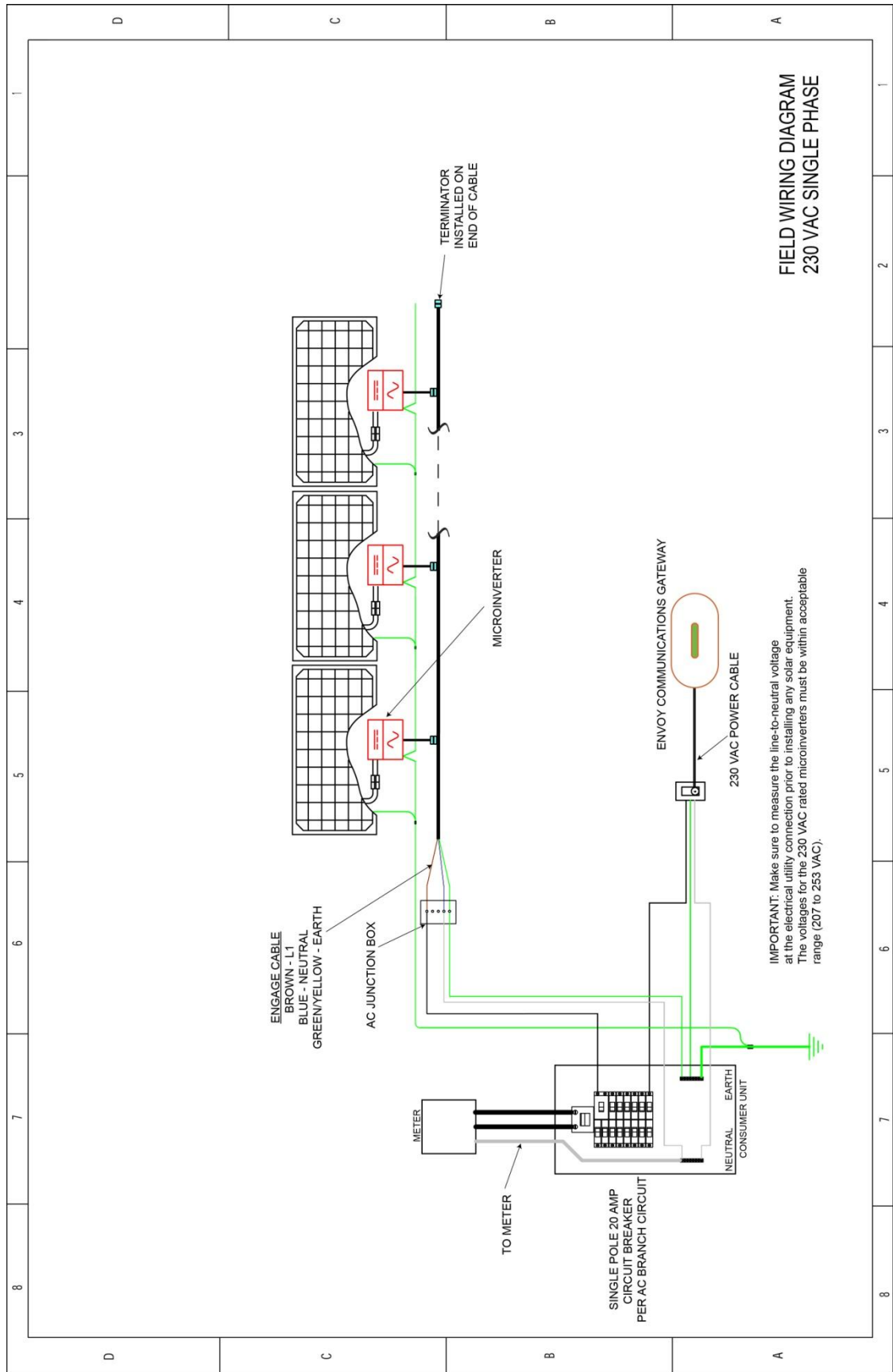

### Sample Wiring Diagram – 230 VAC, Three-Phase

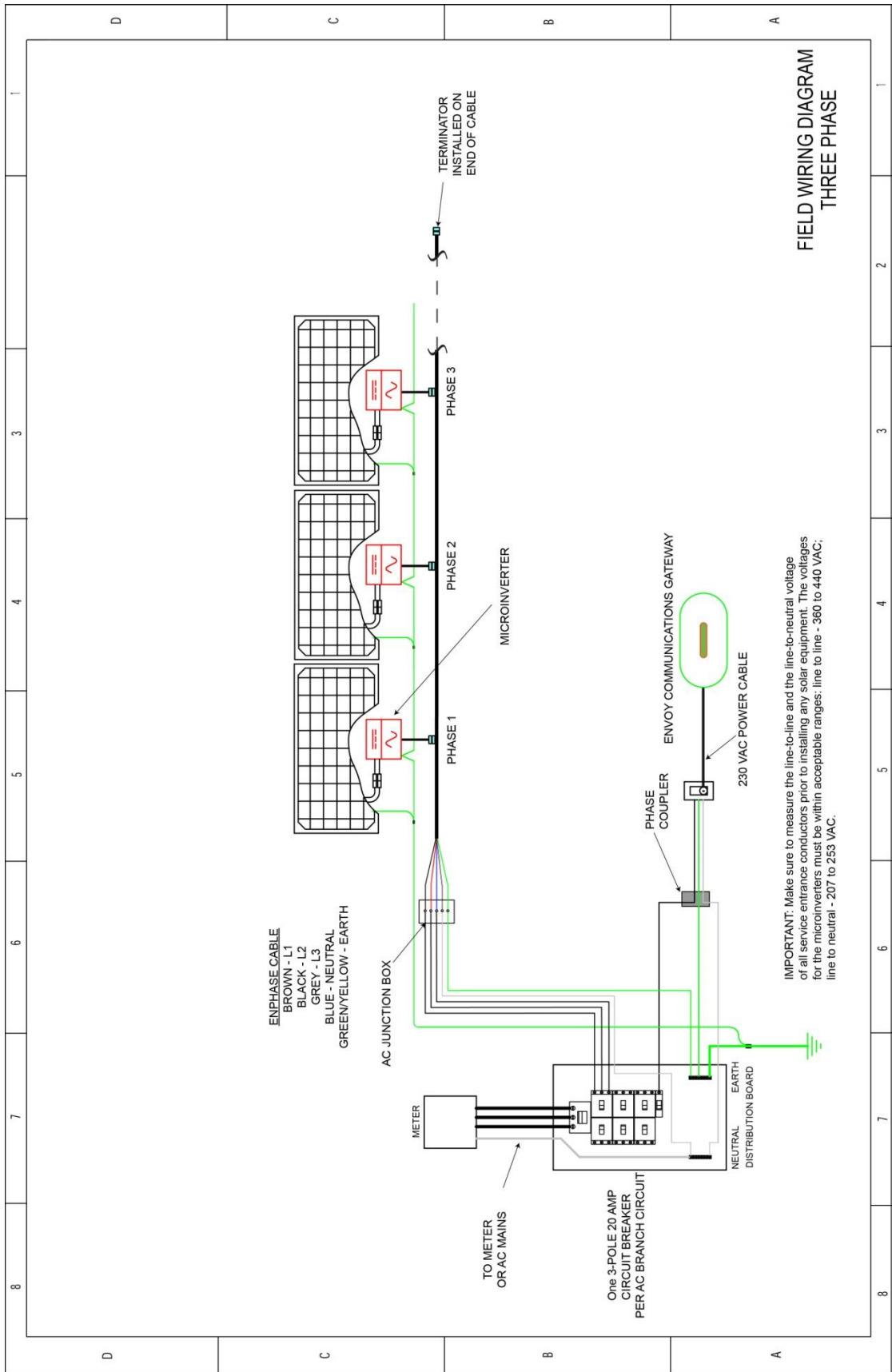



**Corporate Headquarters Contact Information**

Enphase Energy Inc.  
1420 N. McDowell Blvd.  
Petaluma, CA 94954  
USA

<http://www.enphase.com>  
[info@enphaseenergy.com](mailto:info@enphaseenergy.com)