

Microinverter and Cable Safety

Important Safety Information (M250-60-230-S22 and M215-60-230-S22-E)

This document contains important instructions to use during installation of the Enphase[®] Microinverter System[™]. To reduce the risk of electrical shock, and to ensure the safe installation and operation of the Enphase Microinverter System, follow these instructions. The following safety symbols and information indicate dangerous conditions and important safety instructions.

Product Labels

	WARNING: Hot surface.
	DANGER: Risk of electric shock.
	Refer to product instructions.

Safety and Advisory Symbols

	DANGER: This indicates a hazardous situation, which if not avoided, will result in death or serious injury.
	WARNING: This indicates a situation where failure to follow instructions may be a safety hazard or cause equipment malfunction. Use extreme caution and follow instructions carefully.
	WARNING: This indicates a situation where failure to follow instructions may result in burn injury.
	NOTE: This indicates information particularly important for optimal system operation. Follow instructions carefully.

Safety Instructions















General Safety	
	CAUTION: Before installing or using the Enphase Microinverter, read all instructions and cautionary markings in the technical description, on the Enphase Microinverter System, and on the photovoltaic (PV) equipment.
	DANGER: Risk of electric shock. Do not use Enphase equipment in a manner not specified by the manufacturer. Doing so may cause death or injury to persons or damage to equipment.
	DANGER: Risk of electric shock. Be aware that installation of this equipment includes risk of electric shock. Do not install the AC junction box without first removing AC power from the Enphase System.
	DANGER: Risk of electric shock. The DC conductors of this photovoltaic system are ungrounded and may be energised.
	WARNING: Risk of electric shock. Always de-energise the AC branch circuit before servicing. Never disconnect the DC connectors under load.
	WARNING: Risk of electric shock. Risk of fire. Only use electrical system components approved for wet locations.
	WARNING: Risk of electric shock. Risk of fire. Only qualified personnel should troubleshoot, install, or replace Enphase Microinverters or the Engage Cable and Accessories.
	WARNING: Risk of electric shock. Risk of fire. Ensure that all AC and DC wiring is correct and that none of the AC or DC wires are pinched or damaged. Ensure that all AC junction boxes are properly closed.











	WARNING: Risk of electric shock. Risk of fire. Do not exceed the maximum number of microinverters in an AC branch circuit as listed in this guide. You must protect each microinverter AC branch circuit with a 20A maximum breaker.
	WARNING: Do not connect Enphase Microinverters to the grid or energise the AC circuit(s) until you have completed all of the installation procedures and received prior approval from the electrical utility company.
	NOTE: To ensure optimal reliability and to meet warranty requirements, install the Enphase Microinverters and Engage Cable according to the instructions in this guide.
	NOTE: Perform all electrical installations in accordance with all applicable local standards.
	NOTE: The AC and DC connectors on the cabling are rated as a disconnect only when used with an Enphase Microinverter.
	NOTE: Protection against lightning and resulting voltage surge must be in accordance with local standards.
	NOTE: Many PV modules have a central stiffening brace. In these cases, do not position the connector and microinverter at the exact centre of the PV module. Instead, position the drop connectors so that the connectors do not conflict with the braces.
	NOTE: Completely install all microinverters and all system AC connections prior to installing the PV modules.



140-00064-02

Safety Instructions, continued

Microinverter Safety	
	WARNING: Risk of skin burn. The body of the Enphase Microinverter is the heat sink. Under normal operating conditions, the temperature is 15°C above ambient, but under extreme conditions the microinverter can reach a temperature of 80°C. To reduce risk of burns, use caution when working with microinverters.
	WARNING: Risk of electric shock. Risk of fire. If the AC cable on the microinverter is damaged, do not install the microinverter.
	WARNING: Risk of electric shock. Risk of fire. Do not attempt to repair the Enphase Microinverter; it contains no user-serviceable parts. If it fails, contact Enphase customer service to obtain an RMA (return merchandise authorization) number and start the replacement process. Tampering with or opening the Enphase Microinverter will void the warranty.
	WARNING: Risk of equipment damage. The M215 and M250 may be paired only with 60-cell PV modules.
	WARNING: You must match the DC operating voltage range of the PV module with the allowable input voltage range of the Enphase Microinverter.
	WARNING: The maximum open circuit voltage of the PV module must not exceed the specified maximum input DC voltage of the Enphase Microinverter.
	WARNING: Risk of equipment damage. The microinverter must be installed under the module, out of rain and sun. Do not mount the microinverter in a position that allows long-term exposure to direct sunlight or in a vertical orientation that allows water to collect in the DC connector recess. Do not install the microinverter black side up or vertically, with the DC connectors facing up.
	WARNING: Risk of electric shock. Risk of fire. Be aware that only qualified personnel may connect the Enphase Microinverter to the utility grid.
	NOTE: The microinverters will not produce power until the Envoy Communications Gateway is installed and configured with an appropriate grid profile. For instructions, refer to the Envoy Installation and Operation Manual at http://www.enphase.com .
	NOTE: The Enphase Microinverter has field-adjustable voltage and frequency trip points that need to be set. Only an authorised installer with the permission and following requirements of the local electrical authorities should make adjustments.
	NOTE: The Enphase Microinverter operates with single-phase or three-phase electrical service.
Engage Cable and Accessory Safety	
	DANGER: Risk of electric shock. The Engage Cable terminator cap must not be installed while power is connected.
	WARNING: Risk of electric shock. Risk of fire. When stripping the sheath from the Engage Cable, make sure the conductors are not damaged. If the exposed wires are damaged, the system may not function properly.
	WARNING: Risk of electric shock. Risk of fire. Do not leave AC connectors on the Engage Cable uncovered for an extended period. If you do not replace the microinverter immediately, you must cover any unused connector with a sealing cap. Sealing caps may not be reused.

	WARNING: Risk of electric shock. Risk of fire. Make sure protective sealing caps are installed on all unused AC connectors. Unused AC connectors are live when the system is energised. Sealing caps may not be reused.
	WARNING: Risk of Electrical Shock. Treat all connector contacts as though they are live. The 5G2.5 Engage Cable drop connector contains two live phases.
	WARNING: Use the terminator only once. If you open the terminator following installation, the latching mechanism is destroyed. Do not reuse the terminator. If the latching mechanism is defective, do not use the terminator. Do not circumvent or manipulate the latching mechanism.
	CAUTION: When installing the Engage Cable, secure any loose cable to minimise tripping hazard.
	NOTE: Check the labelling on the Engage Cable drop connectors to be sure that the cable matches the electrical service at the site. Use 5G2.5 Engage Cable at sites with three-phase service, or use 3G2.5 Engage Cable at sites with single-phase service.
	NOTE: There are two release-holes in the drop connector on the cable. These are not for mounting but are used to disconnect the connector. Keep these release holes clear and accessible.
	NOTE: When looping the Engage Cable, do not form loops smaller than 12 cm in diameter.
	NOTE: If you need to remove a sealing cap, you must use the Enphase disconnect tool or a screwdriver. Sealing caps may not be reused.
	NOTE: When installing the Engage Cable and accessories, adhere to the following: <ul style="list-style-type: none"> • Do not expose the terminator cap or cable connections to directed, pressurised liquid (water jets, etc.). • Do not expose the terminator cap or cable connections to continuous immersion. • Do not expose the terminator cap or cable connections to continuous tension (e.g., tension due to pulling or bending the cable near the connection). • Use only the connectors and cables provided. • Do not allow contamination or debris in the connectors. • Use the terminator cap and cable connections only when all parts are present and intact. • Do not install or use in potentially explosive environments. • Do not allow the terminator to come into contact with open flame. • Make sure that all terminator cap seals are seated correctly in the wire organiser. • Fit the terminator cap using only the prescribed tools and in the prescribed manner. • Use the terminator to seal the conductor end of the Engage Cable; no other method is allowed.
	NOTE: Do not use the shipping cap to cover unused connectors. The shipping cap does not provide an adequate environmental seal. Enphase sealing caps are required to protect against moisture ingress.

Installing Enphase Microinverters and the Engage Cable (M250-60-230-S22 and M215-60-230-S22-E)

NOTE: Enphase Microinverters will not produce power until the Envoy® Communications Gateway is installed and configured with an appropriate grid profile. Instructions are included in this document.

1

Register the System

Register the System at the Enlighten website:
<https://enlighten.enphaseenergy.com>.

a. Log in to Enlighten.

- At the installer dashboard, click **Add a New System**.

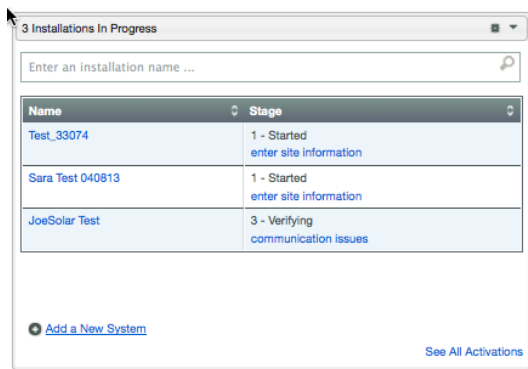

System Activation form

b. Enter System Activation Information

- Enter the System, Installer, Owner, and Location information.
- Enter the Envoy serial number. The serial number label is on the back of the Envoy, near the left mounting bracket.

c. Select the Grid Profile

Once you select your **Country**, the Grid Profile menu appears.

- Select the appropriate profile from the **Grid Profile** menu.
- Click **Save** to submit the form.

For more information on Grid Profiles, refer to the *Envoy Communications Gateway Installation and Operation Manual* at: <http://www.enphase.com/support>.



The microinverters will not export power until the Envoy is installed and detects all the microinverters at the site. The grid profile must also be set and propagated to the microinverters.

2

Connect the Envoy® Communications Gateway™

- Connect the Envoy to power and Internet according to the *Envoy Communications Gateway Quick Install Guide*.
- During start up, the Envoy LCD panel scrolls through the available language settings. When you see the setting you prefer, press the Menu button and hold for two seconds.
- Look for the + Web indication on the LCD screen.
- Leave the Envoy on while you install the microinverters so that any required Envoy software upgrade completes.

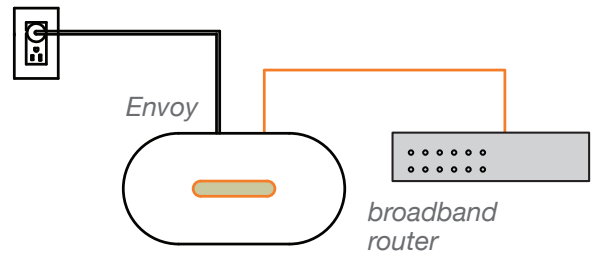

Warning: Do not remove power from the Envoy if the LCD displays: "Upgrading. . . Do Not Unplug."

3

Position the Enphase Engage™ Cable

- Plan the cable length to allow drop connectors on the Engage Cable align to with each PV module. Allow extra length for slack, cable turns and any obstructions.
- Cut a length of Engage Cable to meet your planned needs.
- Lay out the cabling along the installed racking for the AC branch circuit.

4

Install an AC Junction Box

- Install an appropriately rated, off-the-shelf junction box at a suitable location.
- Provide an AC connection from the AC junction box back to the electricity network connection using equipment and practices as required by local jurisdictions.

See notes in **Step Details**.

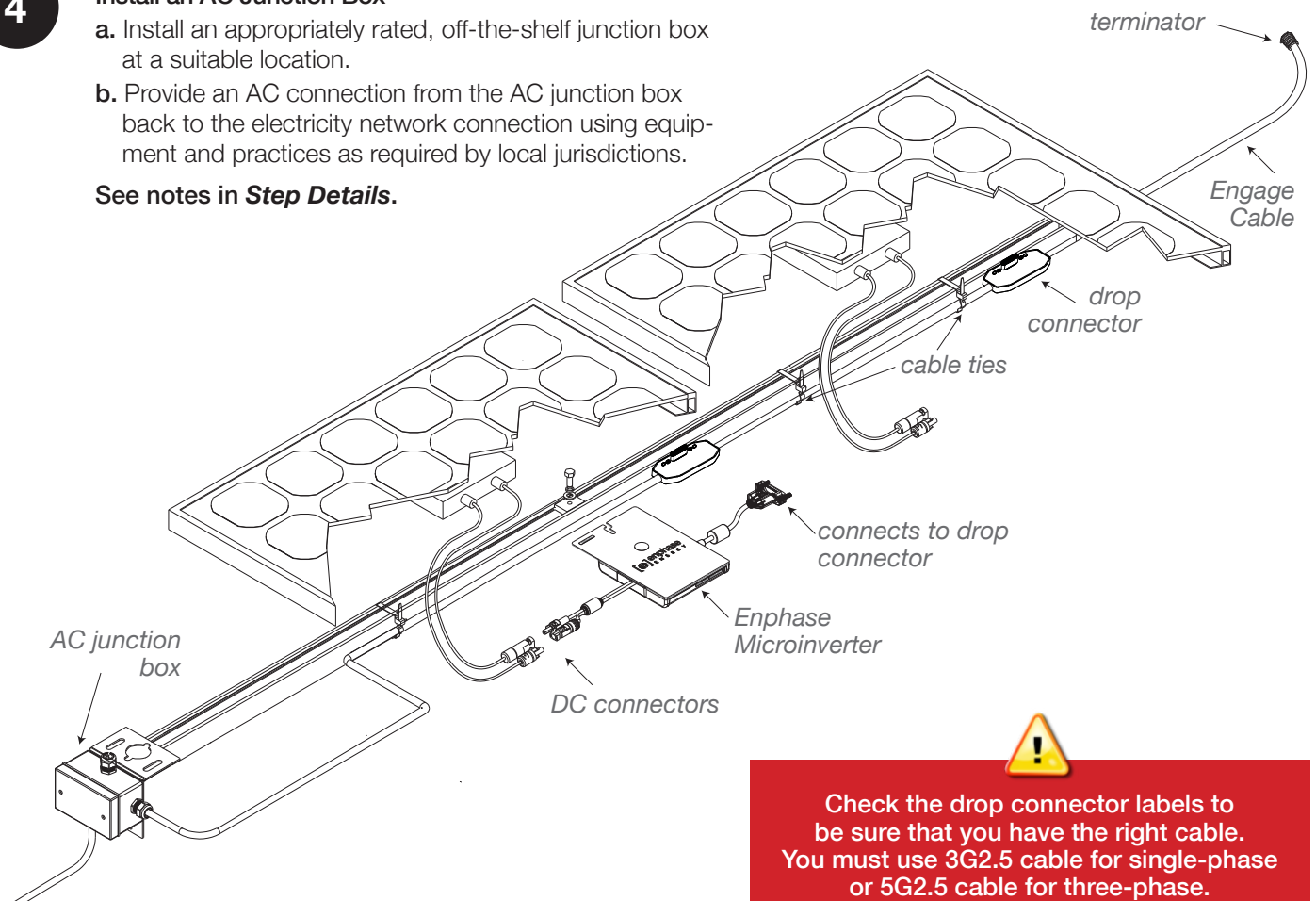

Check the drop connector labels to be sure that you have the right cable. You must use 3G2.5 cable for single-phase or 5G2.5 cable for three-phase.

QUICK INSTALL GUIDE

5 Attach the Microinverters to the PV Rail

- a. Mark the approximate centres of each PV module on the PV mounting rail. **See notes in Step Details.**

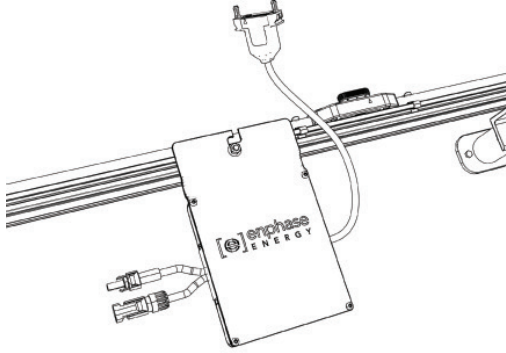

- b. Mount the microinverter under the PV module, away from rain and sun. Do not mount the microinverter in a position that allows long-term exposure to direct sunlight or in a vertical orientation that allows water to collect in the DC connector recess.
- c. Torque the microinverter fasteners as follows. Do not over torque:
- 5 N m for 6 mm hardware
 - 9 N m for 8 mm hardware
- d. If required, bond (earth) the microinverter chassis to the mounting rail.

6 Dress the Cable

- a. Use tie wraps to attach the cabling to the mounting rail.

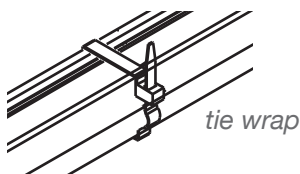

Keep the drop connector release holes clear and accessible.

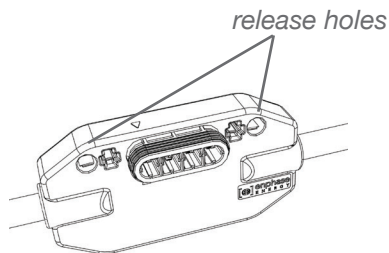

- b. Dress any excess cabling in loops so that it does not contact the roof. Do not form loops smaller than 12 cm in diameter.

7 Connect the Microinverters

- a. Remove and discard the temporary shipping cap from the cable connector and connect the microinverter. Listen for two clicks as the connectors engage.

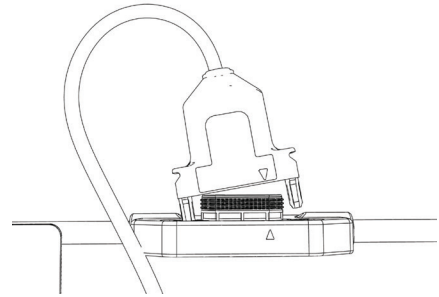

- b. Cover any unused connectors with Enphase Sealing Caps. Listen for two clicks as the connectors engage. **See notes in Step Details.**

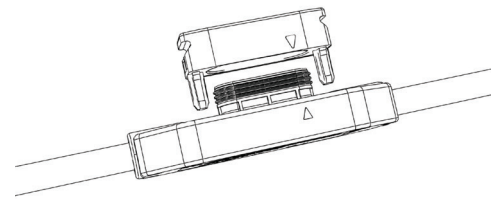

Do not use shipping caps to cover unused connectors. The shipping cap does not provide an adequate environmental seal.

8**Terminate the Unused End of the Cable**

- a. Remove 60 mm of the cable sheath from the conductors.

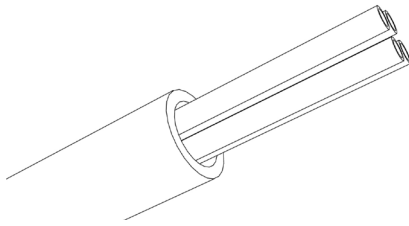

- b. Check that all terminator parts are present.

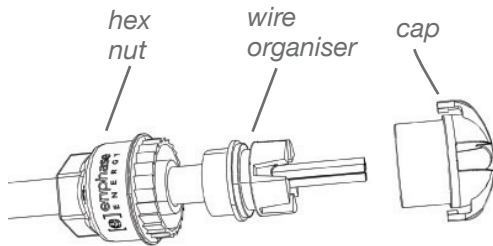

- c. Slide the hex nut onto the cable.
 d. Insert the cable end all the way into the wire organiser (up to the stop).
 e. Attach the cap.

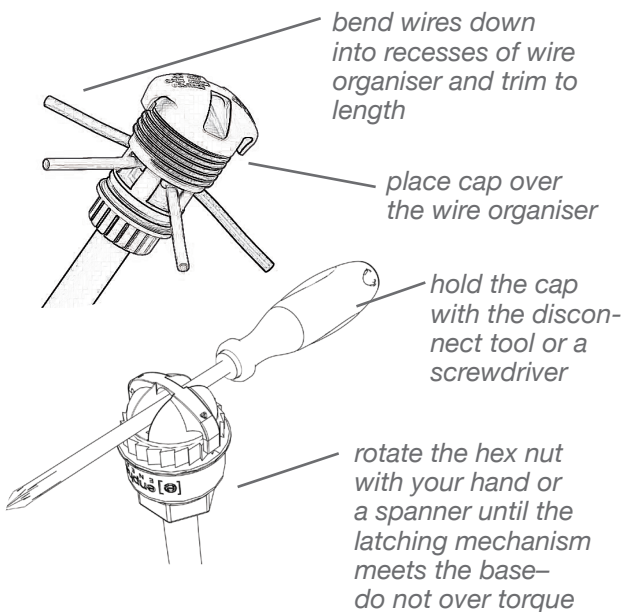

- f. Attach the terminated cable end to the PV mounting rail with a tie wrap.



Never unscrew the hex nut. This action can twist and damage the cable.

9**Connect the Cable to the AC Junction Box**

Connect the Engage Cable into the AC branch circuit junction box. **See notes in Step Details.**

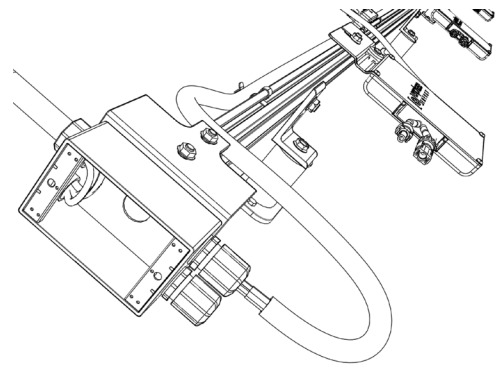
**10****Complete the Installation Map**

Build the system map manually, or use the ArrayGun feature from the Enphase Installer Toolkit to easily build and configure a system. For more information, refer to <http://www.enphase.com/products/arraygun>.

To manually build the Installation Map:

- a. Peel the removable serial number label from each microinverter and affix it to the respective location on the installation map included with this guide.
 b. Peel the label from the Envoy and affix it to the installation map.
 c. Log in to Enlighten.
 d. Scan the installation map and upload it to the System Activation form online.
 e. Use Array Builder to create the virtual array using the installation map as your reference.
 f. Refer to the Array Builder demo at <http://www.enphase.com/support/videos>.

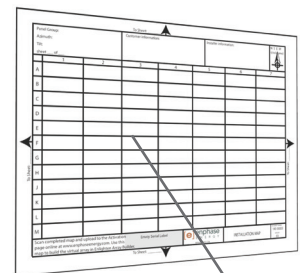

affix serial number labels

11**Connect the PV Modules**

- a. Mount the PV modules above the microinverters.
 b. Connect the DC leads of each PV module to the DC input connectors of their corresponding microinverter.

The status LED on the underside of each microinverter lights green six seconds after DC power is applied. It remains lit solid for two minutes, followed by six green blinks. After that, red blinks indicate that no grid is present. This is because the AC circuit is not yet energised.

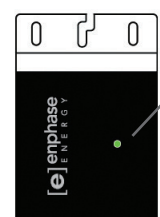

status LED

12

Energise the System

- a. If applicable, turn ON the AC disconnect or circuit breaker for the branch circuit.
- b. Turn ON the main utility-grid AC circuit breaker.

13

Use the Envoy to Complete System Setup

Refer to the to the *Envoy Quick Install Guide* for details on the following steps:

- a. An automatic device scan runs for eight hours after the Envoy is installed. If this scan has expired, start a new scan:
 - Press and hold the Envoy menu button (on the right side of the Envoy).
 - Release the menu button when the LCD screen displays **Enable Device Scan**.
- b. Use the Envoy menu button to select **Enable Communication Check**. Ensure at least three level bars show on the LCD.
- c. When all devices are detected, stop the scan. To do this, use the Envoy menu button to select **Disable Device Scan**.

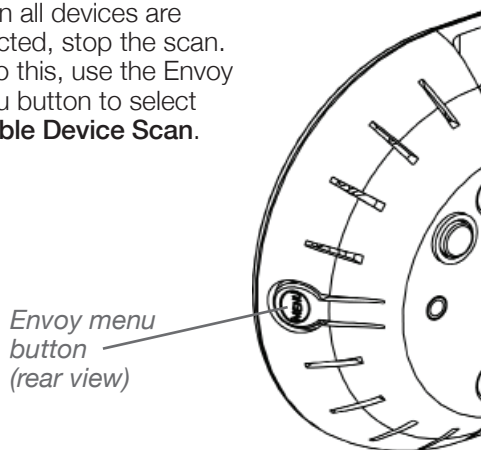

Step Details

4

NOTE: Verify that AC voltage at the site is within range:

Single-Phase Service		Three Phase Service	
L1 to N	207 to 253 VAC	L1 to L2 to L3	360 to 440 VAC
		L1, L2, L3 to N	207 to 253 VAC

WARNING: Only use electrical system components approved for wet locations.

WARNING: Do not exceed the maximum number of microinverters in an AC branch circuit as listed in the table below. Each branch circuit must be protected by a 20 A maximum circuit breaker.

Service type	Max Microinverters per branch	
	M215	M250
Single-phase	17	14
Three-phase	27	24
Three-phase, center-fed	51	42

WARNING: Size the AC wire gauge to account for voltage drop. Select conductor diameter based on the distance from the beginning of the microinverter AC branch circuit to the breaker in the AC mains. See the Technical Brief on Voltage Drop at <http://www.enphase.com/support>.

5

DANGER: ELECTRIC SHOCK HAZARD. THE DC CONDUCTORS OF THIS PHOTOVOLTAIC SYSTEM ARE UNGROUNDED AND MAY BE ENERGISED.

WARNING: Allow a minimum of 1.9 cm between the roof and the bottom of the microinverter. Also allow 1.3 cm between the back of the PV module and the top of the microinverter.

NOTE: The AC output neutral is not bonded to earth inside the microinverter.

NOTE: Torque the microinverter fasteners to the values shown. Do not over torque.

- 6mm mounting hardware – 5 N m
- 8mm mounting hardware – 9 N m

NOTE: Using a power screwdriver is not recommended due to the risk of thread galling.

7

WARNING: Install sealing caps on all unused AC connectors as these become live when the system is energised. The IP67-rated sealing caps are required for protection against moisture ingress.

NOTE: To remove a sealing cap, you must use the Enphase disconnect tool or a screwdriver.

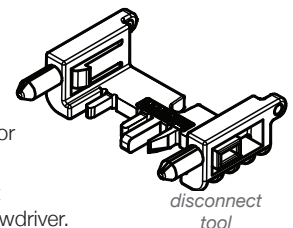



9

NOTE: The Engage Cable uses the following wiring scheme.

Single-Phase Wires	Three-Phase Wires
Brown – L1	Brown – L1
Blue – Neutral	Black – L2
Green/yellow – Ground	Gray – L3
	Blue – Neutral
	Green/yellow – Ground

NOTE: The green wire acts as equipment earth.

To sheet / Vers la page / Al foglio / Zu Blatt / Naar pagina: _____

Panel Group / Groupe de modules / Gruppo di moduli / Modulgruppe / Modulegroep: Azimuth / Azimut: Tilt / Inclinaison / Inclinazione / Neigungswinkel / Helling: sheet / page / foglio / Blatt / pagina _____ / _____		Client / Cliente / Kunde / Cliënt:			Installer / Installateur / Installatore:			N S E W / N S E O N S O W / N Z O W	
1	2	3	4	5	6	7			
A									
B									
C									
D									
E									
F									
G									
H									
J									
K									
L									
M									
Envoy serial label / étiquette de numéro de série / etichette di serie Envoy / Serien Nummer / Label seriennummer:							INSTALLATION MAP / PLAN D'INSTALLATION MAPPA INSTALLAZIONE / INSTALLATIONSPLAN INSTALLATIE KAART		

To sheet / Vers la page / Al foglio / Zu Blatt / Naar pagina: _____

To sheet / Vers la page / Al foglio / Zu Blatt: _____

To sheet / Vers la page / Al foglio / Zu Blatt / Naar pagina: _____

© 2014 Enphase Energy Inc. All rights reserved.